



BEASTX
BE ABSOLUTE STABLE

MADE IN GERMANY

MICROBEAST

3 AXIS MEMS GYRO SYSTEM FOR RC-MODEL AIRCRAFT

Version 3.0

INSTRUCTION MANUAL



BEASTX
BE ABSOLUTE STABLE

MICROBEAST

3 AXIS MEMS GYRO SYSTEM FOR RC-MODEL AIRCRAFT

MADE IN GERMANY

Version 3.0

INSTRUCTION MANUAL

CONTENTS

CONTENTS	4
SAFETY NOTES	6
GENERAL INFORMATION	8
1. INTRODUCTION	9
2. BOX CONTENT	10
3. MOUNTING AND CONNECTION	11
3.1 Mounting the MICROBEAST unit.....	11
3.2 Preparing a transmitter for flybarless	12
3.3 Servo connections and auxiliary channels	13
4. Receiver connection	14
4.1 Connection of a standard receiver	15
4.2 Use of single-line receivers	18
5. Receiver type setup	24
5.1 Receiver type choice (receiver menu point A)	24
5.2 Input channel assignments (receiver menu points B - H)	26
5.3 Programming the Failsafe (receiver menu point N)	31
6. SETUP PROCEDURE OVERVIEW	32
6.1 Setup menu	34
6.2 Parameter menu	34
6.3 Example: Selection within the menus.....	35
6.4 Switching to the next menu point	35
7. SETUP MENU	36
A Mounting orientation of the MICROBEAST.....	37
B Swashplate servo frequency	38
C Tail servo center position pulse length.....	40
D Tail servo frequency	41
E Setting the Tail rotor endpoint	43
F Setting the Tail sensor direction.....	45
G Adjusting the swashplate servo centering	47
H Swashplate mixer	49

①	Setting the swashplate servo directions	50
⓵	Teaching the cyclic pitch geometry	51
Ⓚ	Adjusting the collective pitch range	53
Ⓛ	Adjusting the cyclic swashplate limit	54
Ⓜ	Setting the swashplate sensor directions	55
Ⓝ	Setting the pirouette optimization direction.....	58
8.	DIALS AND TAIL GYRO GAIN	60
8.1	Swashplate: cyclic gain (Dial 1)	60
8.2	Swashplate: direct cyclic feed forward (Dial 2).....	61
8.3	Tail dynamic (Dial 3).....	61
8.4	Tail gyro gain (adjusted by the transmitter)	62
9.	PARAMETER MENU.....	63
Ⓐ	Swashplate cyclic center adjustment.....	64
Ⓑ	Control behavior	65
Ⓒ	Swashplate – pitching up compensation	67
Ⓓ	Tail HeadingLock gain	68
Ⓔ	Stick deadband.....	70
Ⓕ	Tail – torque precompensation (RevoMIX)	71
Ⓖ	Cyclic response.....	72
Ⓗ	Pitch boost.....	73
10.	THE FIRST FLIGHT	74
11.	VERSION DISPLAY	76
12.	TROUBLE SHOOTING	77
	Legal terms	81
	Disclaimer	81
	Copyrights	81
	Declaration of conformity.....	81
	MICROBEAST overview	82
	Adjustment options - overview	83
	My servo setup	84

SAFETY NOTES

 Radio controlled (R/C) helicopters are not toys! The rotor blades rotate at high speed and pose potential risk. They may cause severe injury due to improper usage. It is necessary to observe common safety rules for R/C models and the local law. You can gather information from your local R/C model club or from your national modelers association.

 Pay attention to your own safety and the safety of other people and property in your vicinity when using our product. Always fly in areas away from other people. Never use R/C models in close proximity to housing areas or crowds of people. R/C models may malfunction or crash due to several reasons like piloting mistakes or radio interference, and cause severe accidents. Pilots are fully responsible for their actions, and for damage or injuries caused by the usage of their models.

 The MICROBEAST-System is not a flying aid for beginners! It replaces the conventional mechanical flybar on most R/C helicopters. It is absolutely necessary that you have flying experience and that you are experienced in the operation of R/C helicopters. Otherwise we suggest you to seek the support of an experienced helicopter pilot before you undertake the first flight of your model. Additionally, flight training with a R/C simulator can help make flying easier and more enjoyable. Ask your local dealer if you need technical support or if you observe problems during the usage of our system.

 Please read the following instructions thoroughly before the first use of your MICROBEAST and setup the system carefully according to this manual. Allow sufficient time for the setup procedure and check each step carefully. Watch for a mechanically clean and proper build of your helicopter. A wrong system setup can lead to a serious accident and damage to the model.

 Radio controlled (R/C) models consist of several electrical components. It is therefore necessary to protect the model from moisture and other foreign substances. If the model is exposed to moisture this may lead to a malfunction which may cause damage to the model or a crash. Never fly in the rain or extremely high humidity.

 Do not expose the MICROBEAST-System to extreme variations in temperature. Before powering up the system, wait some time so that the electronics can acclimatize and any accumulated condensation is able to evaporate.

 MICROBEAST consists of highly sensitive electrical components with limited capability to operate with excessive vibrations or electrostatic discharges. If you find such disturbances in your model, the use of MICROBEAST should be postponed until the problems have been fixed.

 When operating the helicopter with a MICROBEAST ensure there is a sufficiently large and stable receiver power supply. Because of the direct coupling of the rotor blades to the servos, without the use of a flybar mixer, the servos are exposed to increased actuating forces. In addition, because of the intermediary electronic gyro system, the servos are driven more often than with traditional use.

These factors can make the power consumption increase a lot compared to a flybar helicopter.

 Particularly when operating electric helicopters with single-line receivers, make sure that the electric motor cannot start inadvertently during the setup procedure, if the ESC is connected directly to the MICROBEAST. We recommend disconnecting the electric motor from the ESC during the setup procedure. Prior the first usage please slide the motor/pinion away from the main gear, then check that the motor does not start inadvertently when the receiver is switched on.

GENERAL INFORMATION

Please note that these instructions are only valid for the MICROBEAST firmware Version 3.x.x!

The delivered software version is printed on a sticker on the outside of the MICROBEAST packaging. You can also read it out on a computer by using the optional USB2SYS Interface and you can directly read on the MICROBEAST unit during the initialization phase, what firmware version your MICROBEAST is running:

The MICROBEAST first carries out a brief LED test by lighting up all menu LEDs simultaneously, and cycling the Status-LED color. Then for about 3 seconds, the Status-LED lights red while the menu LEDs **A** - **G** display the first digit of the firmware version, and the LEDs **H** - **N** the second digit of the firmware version. **Only the first digit of the firmware version is of importance!**

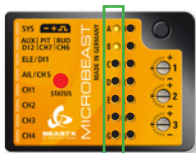

Firmware version 3.x.x

On the first column LEDs **A** and **B** must light corresponding to digit 3. LEDs **H** - **N** are irrelevant for the purposes of this instruction manual.

If only LED **B** is lighting or if the display on initialization is not as described, but **ONLY** a running light of all menu LEDs **A** - **N**, then the MICROBEAST is running an older version. In this case we recommend updating to the latest firmware version. If you like to continue to use the older firmware version, you must also use the appropriate instructions and not this manual!

You will get more information about the version display in section 10 of this manual.

1. INTRODUCTION

Dear customer, thank you for choosing the MICROBEAST!

MICROBEAST is an easy to use three axis gyro system which makes it possible to fly R/C helicopters without a mechanical flybar. This brings a boost in power as well as longer flight times and makes it possible to adapt the agility and flying behavior of your helicopter to your individual preference.

The MICROBEAST has a built-in high end tail gyro based on the latest MEMS Technology which gives your helicopter's tail perfect stopping behavior and constant rotation rate during any manoeuvres.

The MICROBEAST can be used in nearly any size of helicopter, using either electric motors or nitro engines for propulsion. It provides flight stability for beginners and maximum agility and precision for intermediate and professional pilots.

Nevertheless, the MICROBEAST is not a flying aid for beginners! If you are inexperienced with model helicopters, please consult an experienced pilot for help with setup and your first flights.

The following manual will lead you step by step through the setup procedure from the correct mounting of the unit up to the first flight. Please read the following instruction manual thoroughly. You will see that during the development of the MICROBEAST, that our focus is to user friendly and soon you will be able to operate the system intuitively.

The included overview map of the setup menu can be taken out to the flying field as a quick reference to the various menu options.

Check our website WWW.BEASTX.COM where we will inform you about the latest updates and downloads.

Now have fun and a good time using MICROBEAST!

Sincerely, the BEASTX-Team

2. BOX CONTENT

MICROBEAST



Receiver wiring leads 15 cm



Instruction manual



Gyropads



Adjustment tool



Optional accessories (sold separately)

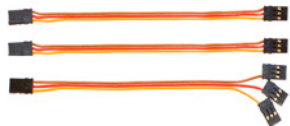

Receiver wiring leads 8 cm

Cable for stand-alone tail gyro use



USB-Interface



Spektrum Adapter



3. MOUNTING AND CONNECTION

3.1 Mounting the MICROBEAST unit

Attach the MICROBEAST unit by using one of the provided gyropads at a preferably low vibrating position on your helicopter such as the gyro platform or receiver platform. You may also need to choose another type of mounting pad depending on the vibration pattern of your helicopter. Ask your MICROBEAST dealer.

The MICROBEAST unit can be attached flat or upright, and even upside down under the helicopter. **However, the servo connector pins must always point toward the front (or rear) of the helicopter.**

Pay attention that **the edges of the MICROBEAST unit are all parallel with the corresponding axes of the helicopter!** And be sure that the mounting platform is perpendicular to the main shaft!

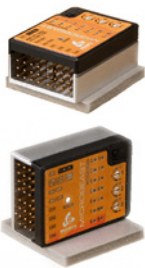

Fig. 1



Fig. 2

3.2 Preparing a transmitter for flybarless

(This step is unnecessary when using the MICROBEAST with the optional cable for stand-alone tail gyro use. Please see 4.1.2)

First create a new model in your radio's model memory. When using the MICROBEAST you have to disable any mixing functions for the swashplate or tail. Each function should be assigned to just one receiver channel. As you see our requirement for the transmitter is very low.

Be sure that all trims and sub trims are disabled and that all servo travel are 100% (increasing or decreasing the servo travel for aileron, elevator and rudder can later adjust the maximum control rates, see chapter 9-**6**).

Never enable your radio's eCCPM mixing function: this will be done by the MICROBEAST. Always set your radio's swash mixer to mCCPM (mechanical mixing) which is often called "H1" or "1 servo" mixing.

Do not adjust the pitch curve at the moment. For the setup procedures, it has to be set as a straight line from -100% to +100% (or 0 to 100% depending on radio brand).

Again make sure that there are no mixing functions active (for example revo-mixing).

Other functions such as throttle curves, ESC switches or auxiliary functions can be adjusted as usual.

3.3 Servo connections and auxiliary channels

In slot CH1 is the elevator servo. With electronic swashplate mixing the two roll servos have to be connected to CH2 and CH3, with a mechanical mixed head (H1) the roll servo connects to CH2 and CH3. The tail servo is always connected on CH4.

Fig. 3

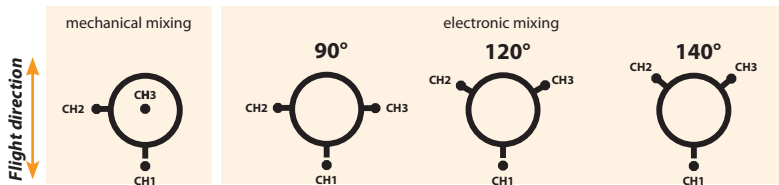

Don't plug the servos into the MICROBEAST yet! The correct servo type and appropriate driving frequency has not yet been selected in the Setup menu. We recommend not installing the servo horns yet as the servos could bind and get damaged on first power up.

When you route the wire leads in your model make sure that there is no tension passed to the MICROBEAST. Make sure that the MICROBEAST is able to move freely, so no vibrations get passed onto the unit.

It is not recommended to bundle or tie down the leads **close** to the MICROBEAST.

On the other hand the wires must be attached so that they are unable to move the MICROBEAST during the flight. In particular, do not use any shrink tubing or fabric hose to bundle or encase the wiring in close proximity to the point at which the cables are plugged into the Microbeast. This makes the cable stiff and inflexible and can cause even the slightest vibrations are transmitted to Microbeast.

At this point we would like to point out that the correct dimensioning of receiver power supply is very important (BEC and battery current rating, number of supply cables, cable diameter, cable length ...). For flybarless helicopters, the load on the servos and the resulting power consumption is significantly higher than for helicopters with a flybar! Also the servos are constantly in motion when used with an electrical control system.

4. RECEIVER CONNECTION

In relation to the control of MICROBEAST you have the opportunity to use different types of receivers. It is distinguished between conventional standard receivers and so-called single-line receivers:

A **standard receiver** is a receiver that is connected to the MICROBEAST by using any single servo output of the receiver to connect the five control channels between MICROBEAST and receiver. The channel which determines the controlled function simply is selected by inserting each plug to the correct output at the receiver. In section 4.1.1 it is shown how to exactly connect the receiver to the MICROBEAST when using the MICROBEAST as flybarless system. In addition the use of MICROBEAST is possible as a stand-alone tail gyro. See section 4.1.2 to learn how to connect receiver and MICROBEAST in this case.

When using a **single-line receiver** all channels are transmitted by one single connection line to the MICROBEAST. Because of this, it is not possible here by inserting the appropriate plugs in the receiver to assign functions to the MICROBEAST. This must be done by a specific setting in the MICROBEAST (described in chapter 5).

Also single-line receivers similar to standard receivers with additional single channel connectors are available. Therefore you only have to treat such receivers as single-line receivers in combination with MICROBEAST if you really use this function.

How different types of single-line receivers are connected to the MICROBEAST is described in section 4.2.

Use as a stand-alone tail rotor gyro in single-line mode is possible under certain circumstances, but not intended and therefore is not described further in the following.

4.1 Connection of a standard receiver

4.1.1 Flybarless usage

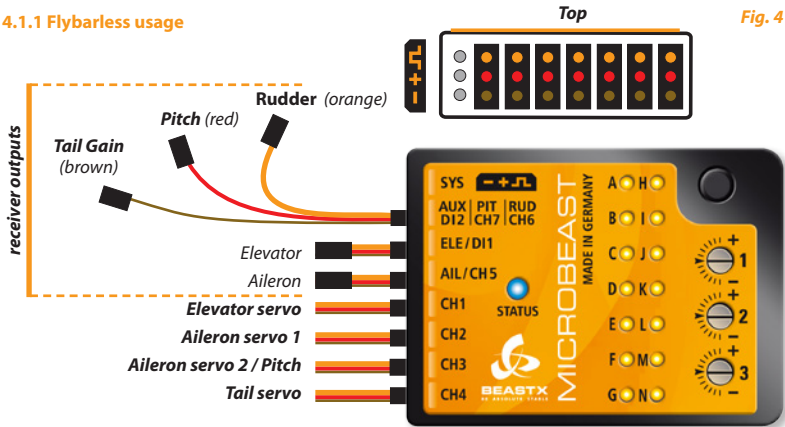

Now plug the receiver cables for aileron, elevator, pitch, rudder and tail gain between the MICROBEAST and the receiver. To find out the channel assignments of your remote control receiver, please refer to the user manual of your transmitter or contact its manufacturer.

To connect **elevator and aileron**, use the plain 3-wire cables that transmit the control signal in addition to the power supply from the receiver to the MICROBEAST.

Pitch (red), **tail** (orange) and **gain** (brown) have only one lead for the control signal on the receiver side, and are connected to the MICROBEAST on the combined connector. Please ensure these plugs are connected correctly to the receiver. Although the cable color is different, all three wires are signal lines, which go to the usual orange, yellow or white side! + and - remain open on these channels.

Please respect the polarities for the plugs going to the MICROBEAST. The orange line on the MICROBEAST must always be on the top and the brown on the bottom. **Also be sure when inserting the connectors not to accidentally plug them into the space next to the pins or vertically offset by one pin.**

Other wires such as throttle servo, ESC or power supplies are connected as usual to the remote control receiver.



Abb. 5

The illustrations are only examples. Of course, the MICROBEAST also works with other receivers and remote control systems.

Remember that it is not the receiver that is crucial for the channel order but that this depends primarily on the allocation of control functions in the transmitter. If you do not know in which order the channels of your transmitter / receiver have to be connected, refer to the instructions that came with your transmitter and receiver, see the servo monitor of the transmitter (if available) or contact the manufacturer of your remote control system.

4.1.2 Usage as stand-alone tail gyro

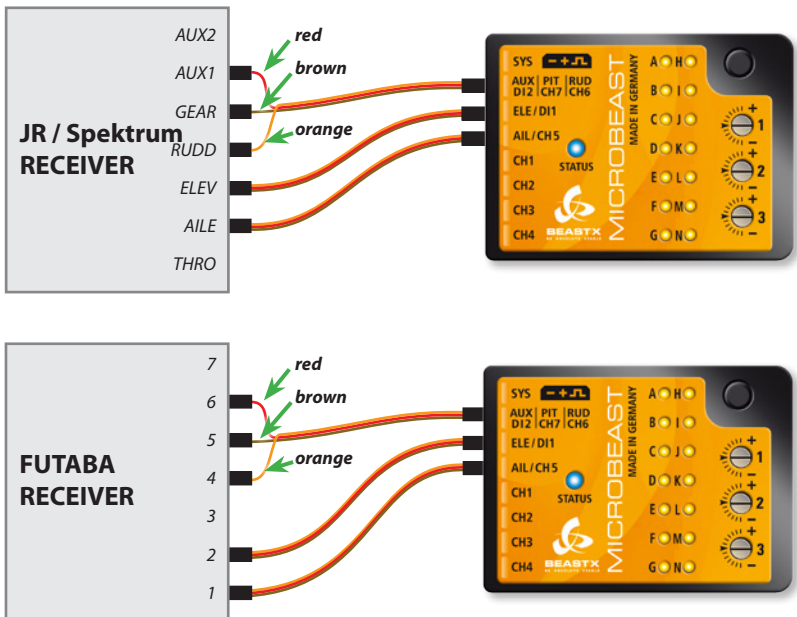
The MICROBEAST can also be used as high-end stand-alone tail gyro. This requires the use of a special patch cable which can be purchased separately. This ensures that the MICROBEAST is provided with power and that the signals for rudder and tail gain are available from the receiver.

The signal lead with the orange and yellow wires must be connected to the slot [**Aux | Pit | Rud**]. The orange wire must be closest to the topside of the MICROBEAST.

The power lead must be plugged into the slot [**ELE | DI1**]. The brown wire (negative or ground) is on the bottom, the red wire (positive or power) should be in the middle position. Connect the tail servo to [**CH4**].

If using the MICROBEAST as stand-alone tail gyro only the menu points A, C, D, E and F need be adjusted in setup menu. All other menu points can be skipped.

To avoid damage to the tail servo, first setup menu points C and D which are tail servo pulse and frequency, prior to connecting the servo.

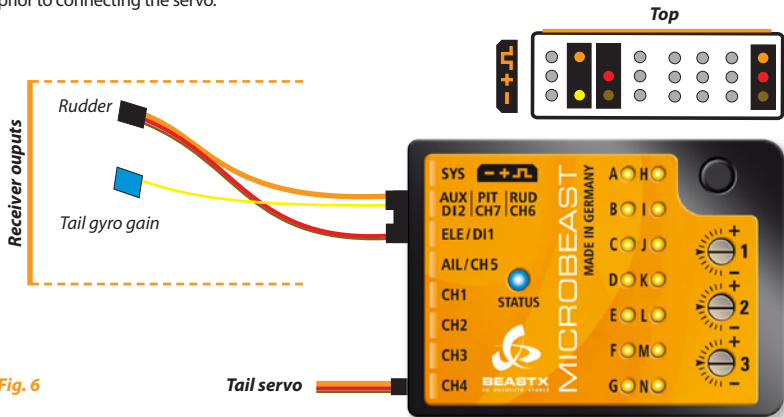

Fig. 6

4.2 Use of single-line receivers

The MICROBEAST enables the use of conventional receivers with individual channel outputs or the use of special receivers which output the channel signals as a merged single-line signal. These include Spektrum® satellite receivers, PPM composite signal receiver (e.g. Futaba® SP Series receiver or the satellite receiver from Jeti ®), receivers with Futaba® S-BUS as well as receivers with SRXL compatible data output (e.g. SRXL-Multiplex or BEASTRX).

4.2.1 General notes

When operating with single-line receivers (Spektrum® satellite receiver, PPM composite signal receiver - e.g. Futaba® SP-series or the satellite receiver from Jeti®, receivers using Futaba® S-BUS, SRXL compatible receivers), the throttle servo/motor controller can be connected to [CH5] on the MICROBEAST. When using a motor controller for electric models with a BEC this slot then also will be supplying the MICROBEAST, the servos and the receiver with power.

We recommend if possible (e.g. on all receivers that have normal servo connectors together with single line output) to connect the throttle servo/motor controller directly to the receiver to benefit from the native Failsafe/Hold functions. Although the MICROBEAST also has adjustable Failsafe for [CH5] this will only be activated when the connection between MICROBEAST unit and receiver fails but not for example in case of signal loss between transmitter and receiver.

On slot **[DI2 | CH7 | CH6]** another auxiliary channel is available on the top pin **[CH6]**, for example to hook up a governor for nitro engines. Please note that this slot is only issuing a control signal and has no power. For this reason a servo cannot be plugged here directly. The two lower pins [DI2] and [CH7] are reserved for other applications. **Never connect a power source on those two pins: this could damage the MICROBEAST!**

In the case of an electric model if the ESC has a second BEC output or when using a buffering battery this wire can be connected to the [SYS] terminal or (if possible) plugged directly into the receiver.

On models with a separate power supply this can only be connected to the MICROBEAST on slot [SYS]. Therefore please ensure adequate sizing of the supply lines, especially with large models. A second power connection can be derived to the receiver or, by using a Y cable, you can inject a parallel power supply to one of the servo outputs. When using very powerful servos you might even consider using a separate voltage regulating unit that the servos can be connected to.

4.2.2 Spektrum® Satellite receiver

To connect a Spektrum® satellite (remote) receiver on the MICROBEAST a special optional adapter is required. This adapter is connected to the [DI1] input of the MICROBEAST. Please observe correct polarity, the orange signal line must be next to the cover. The cable for the Spektrum® satellite receiver is then plugged into this adapter.

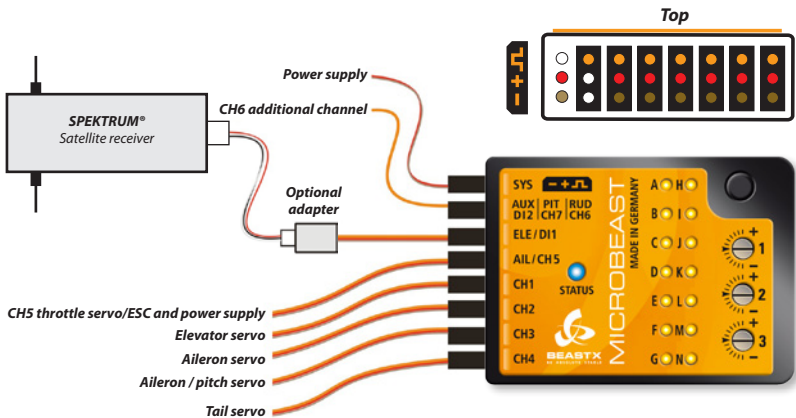

Fig. 7

⚠ The use of MICROBEAST with a single Spektrum® satellite receiver is allowed only on micro or mini helicopters (450 size helicopters) because of the limited range due to the lack of antenna diversity!

Binding procedure

In the case of using a Spektrum® satellite receiver it is very important to bind the receiver first before programming the MICROBEAST. **This step is essential to perform**, even if the satellite was already in use elsewhere (e. g. in connection with a “standard” Spektrum® receiver) and was already bound to the transmitter earlier.

To bind a satellite receiver, it must be connected via the adapter to the MICROBEAST.

Simultaneously with the binding process, the type of satellite receiver has to be set, i.e. whether it is a DSMX or DSM2 satellite (The actual selected signal protocol in the transmitter is not relevant!). It is very important to choose the correct type of satellite receiver here, since an improper setting may seem to work but can lead to radio interference or total loss of the link in the subsequent operation!

Insert a Spektrum® “Bind Plug” in the [SYS] slot on MICROBEAST.

In cases where power is supplied exclusively by the [SYS] Connection, to bind a Spektrum® satellite receiver, the power supply must be provided temporarily through any of the servo port (CH1 - CH5).

To select a **DSM2** satellite and to enter bind mode, simply switch on the power supply now. The LED on the receiver and LED **(N)** on the MICROBEAST will start to flash. You can bind the transmitter as usual (for more information refer to the instructions of your radio control system).

To select and bind a **DSMX** satellite, hold down the button on the MICROBEAST while switching on the power supply. Now the receiver’s LED and LED **(H) (!)** on the MICROBEAST will flash and you can release the button and bind the receiver with your transmitter.

After successful binding procedure the receiver’s LED will stay solid. LED **(H)** respectively **(N)** flash alternately to all other LEDs. Now switch off the power supply and remove the bind plug. Now continue with receiver type setup (see next chapter).

Note: It makes no difference if you pull off the “Bind Plug” during the binding process or leave it connected as you would expect from some “standard” Spektrum® receivers.

Watch out that the motor can not start accidentally when using the BEC of your speed controller to power the unit!

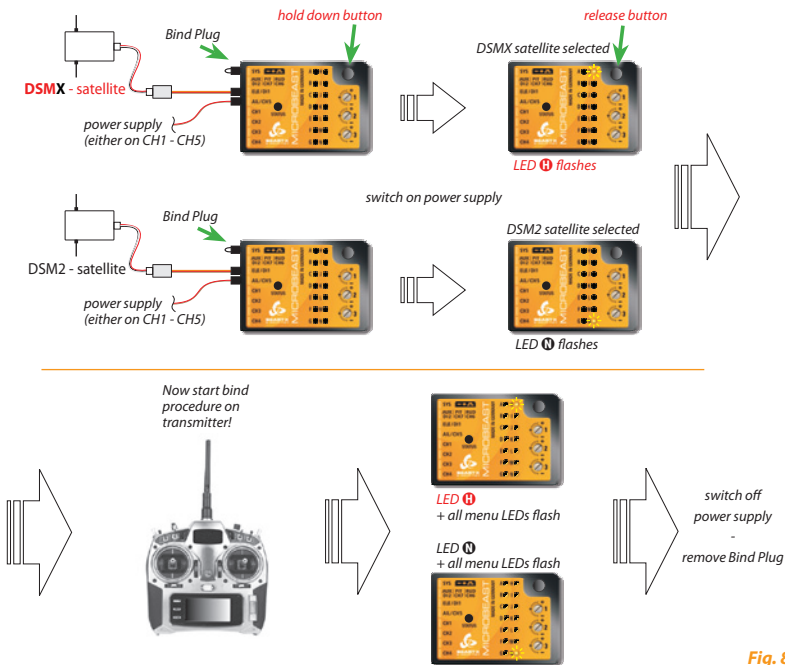

Fig. 8

Decisive for the selection alone is, which type of satellite receiver is plugged in! It is irrelevant which transmission method between the receiver and transmitter is actually used.

Check carefully what type you use. Crucial is the firmware on the satellite not its look! An incorrect setting is not obvious, but later will lead to malfunction or failure of the connection.

4.2.3 Connecting single line receivers without additional servo outputs (e.g. PPM composite signal receivers)

For the connection of PPM composite signal receivers there is usually no special adapter required. In most cases (e.g. Futaba®-receivers of the SP-series) the receiver can be connected to the MICROBEAST with one of the supplied regular 3-wire cables. For some receivers, the connecting cable is also already fixed to the receiver (e.g. Jeti® satellite receiver).

If not fixed to the receiver, plug the cable into the output of the digital composite signal of your receiver, usually labeled with "SIG" or the like. Again pay attention to correct polarity. Be careful, since the supplied cable is designed to be used "universally", and the usual Futaba® polarity protection tab is missing.

Plug the other end of the cable into the MICROBEAST input [DI1]. Make sure the polarity is correct; the orange signal line must be next to the MICROBEAST top cover.

Fig. 9

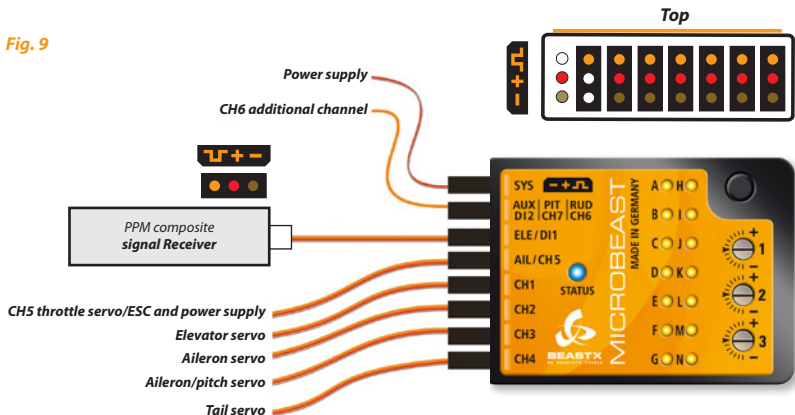

4.2.4 Connection of single line receiver with additional servos connectors (e.g. S-Bus, SRXL)

Connect the receiver to the MICROBEAST with one of the supplied regular 3-wire cables. Plug the cable into the MICROBEAST input [DI1] and the other to the receiver to the output [S. BUS] or [B | D] * for Multiplex.

Please make sure that the connectors are plugged in with the correct polarity. Be careful, since the supplied cable is designed to be used universally, and the Futaba® polarity protection tab missing. On the MICROBEAST, the orange signal wire must be close to the top cover.

This description also applies to other single line receiver with additional servos connectors (e.g. SRXL receivers (Multiplex or BEASTRX)):

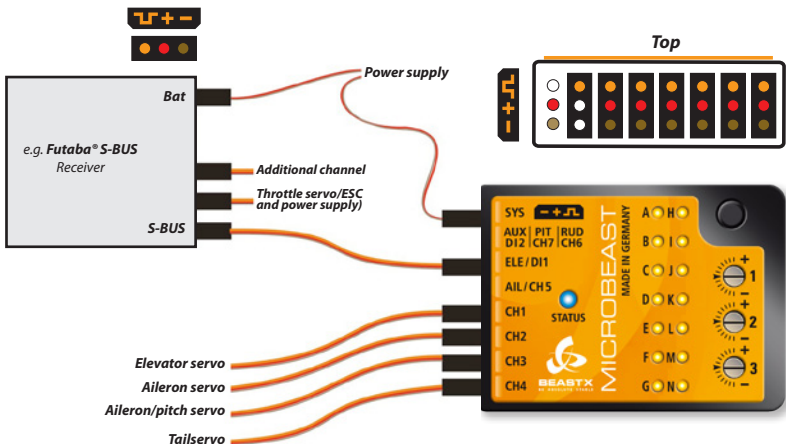

Fig. 10

We recommend to directly connect speed controller and additional functions to the receiver to use the Failsafe / Hold functions of the remote control system (see 4.2.1). But you can also CH5 and CH6 on the MICROBEAST for these functions!

5. RECEIVER TYPE SETUP

Beside using conventional receivers, the MICROBEAST supports the use of different types of single-line receivers. These are receivers which transmit the control signals only over one single cable wiring. If using such a receiver because of the different signal protocols the receiver type must be selected in the receiver menu before the first use and further steps such as allocation of individual channels or failsafe setting are needed. You can see from the yellow LED next to the letters **A** - **I** at which receiver menu point you are currently in. By briefly pressing the button you can go to the next receiver menu point which also saves the current settings.

Note: By default the use of a conventional standard receiver is provided. Therefore it is not necessary to call the receiver setup menu. Skip the following sub-items and proceed with chapter 6.

5.1 Receiver type choice (receiver menu point **A**)

To get into the receiver menu press the button on the MICROBEAST and hold it down while you turn on the receiver power supply. The yellow menu LED **A** should now be flashing and you can release the button.

If you use a motor controller with BEC, disconnect the motor for safety reasons to avoid the possibility of unintentional motor start up!

At menu point **A** where menu LED **A** is flashing, the color and state of the Status-LED gives you information about which type of receiver is currently selected (refer to the table below).

In order to change the type of receiver, **press and hold the button for about 2 seconds**. The Status-LED will light in the next color or eventually flash. Repeat this as many times as required until the Status-LED matches your receiver type:

Status-LED	Receiver type
off	Standard receiver (Fig. 4,5)*
purple	Spektrum® Satellite (Fig. 7)
red flashing	Futaba® S-BUS (Fig. 9,10)
red	SRXL (Fig. 9,10)
blue flashing	PPM - composite signal (Fig. 9,10)

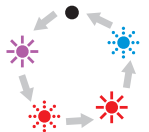

Push and hold
button for
about 2 seconds

*Factory Setting

convention:

LED lights: ☀

LED is flashing: ✨

Then press the button, but only **briefly**, to save the setup and switch to receiver menu point **ⓑ**.
If you have already briefly pressed the button by mistake and it did not change the receiver type but switch to menu point B, switch off the power and repeat the above procedure.

Programming example - operation with a Futaba® S-Bus receiver:

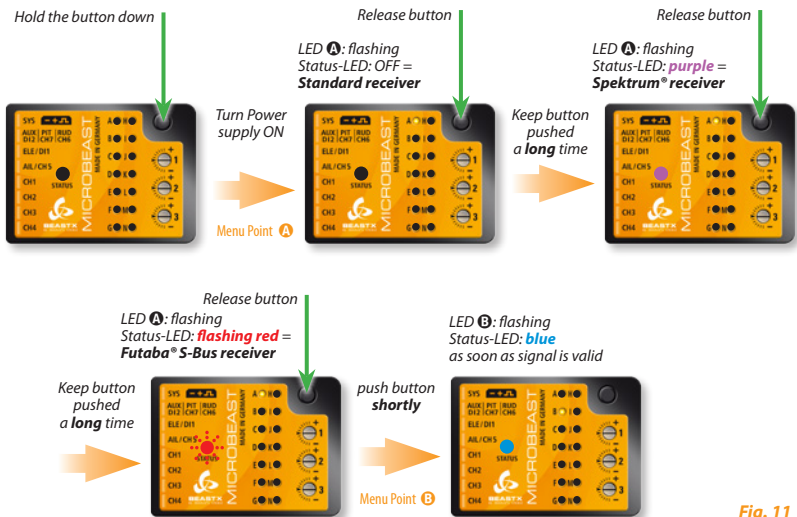

Fig. 11

Note: If selected receiver type is "Standard" the set up is now complete and briefly pushing the button will start the initialization. Another channel assignment is not necessary and not provided since the allocation takes place by appropriate insertion of the cables into the "standard" receiver. So you can directly proceed with chapter 5.

5.2 Input channel assignments (receiver menu points **B** - **H**)

If not a standard receiver but a single-line receiver was selected at menu point **A**, it must be established which control function is controlled by what channel. This is necessary because all the control functions are transmitted via one single line and thus there is no possibility of plugging the cables in each individual channel matching at the receiver.

5.2.1 Preset channel assignment

When selecting a specific type of single line receiver the appropriate type of receiver channel allocation will be preset in the MICROBEAST. Please refer to the tables below and check if your radio transmits the channels in the correct order. If this is not the case, you have to assign the channel order step by step through the menu points **B** - **H** (for this see section 5.2.2). **To know the channel assignment of your transmitter you can check the user manual of the transmitter or look at the servo monitor of the transmitter (if it has this feature). If in doubt ask the manufacturer of your transmitter.**

When using SRXL the preset channel assignment is based on the receiver's protocol version (see next page).

	Spektrum®	Futaba® S-BUS	PPM-Summensignal
transmitter channel assignment	function	function	function
channel 1	throttle (CH5)	aileron	pitch
channel 2	aileron	elevator	aileron
channel 3	elevator	throttle (CH5)	elevator
channel 4	rudder	rudder	rudder
channel 5	tail gyro gain	tail gyro gain	auxiliary (CH6)
channel 6	pitch	pitch	throttle (CH5)
channel 7	auxiliary (CH6)	auxiliary (CH6)	tail gyro gain

	SRXL	
	BEASTRX	Multiplex
transmitter channel assignment	function	function
channel 1	aileron	aileron
channel 2	elevator	elevator
channel 3	throttle (CH5)	rudder
channel 4	rudder	pitch
channel 5	tail gyro gain	throttle (CH5)
channel 6	pitch	tail gyro gain
channel 7	auxiliary (CH6)	auxiliary (CH6)

If you are on receiver menu point **B**, please wait until the Status-LED lights blue.

If the Status-LED stays red, it means that there is no valid remote control signal available. A channel assignment in this case is impossible! If the Status-LED doesn't turn blue after a few seconds, check if the receiver is properly bound to the transmitter (bind already done successfully?) and that a receiver of the correct type is selected in receiver menu point **A**. If a wrong receiver type has been selected, switch off the power and restart the receiver type setup procedure.

Note: If the selected receiver type is "standard" another channel assignment is not necessary and not provided since the allocation takes place by appropriate insertion of the cables into the "standard" receiver. Therefore menu point **B** to **N** are not accessible and the MICROBEAST starts after the brief press at menu point **A** with the initialization (see chapter 6).

To load the selected standard channel assignment (see above tables), hold the button down for several seconds. The menu LED will immediately jump to receiver menu point **N**. In addition, you can also load the default settings by pushing the button for several seconds in any of the points from **C** to **H**. This will erase all previously made individual channel assignments.

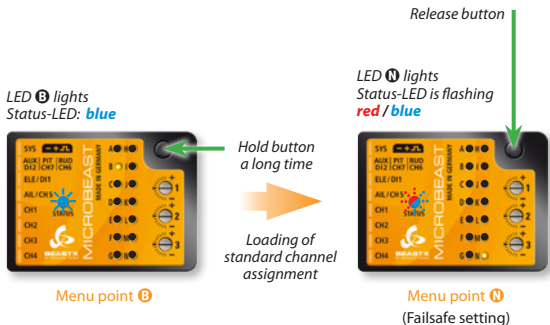

Fig. 12

5.2.2 Teaching of customized channel order

If you need a customized channel order, please first prepare (if not already done) your transmitter as described in section 3.2.

Additionally, make sure (for example, using the servo monitor of your transmitter) that each control function of your transmitter activates one and only one channel. This can be tricky especially for throttle/pitch functions which are usually coupled by a mixer in the transmitter. In this case set the throttle channel quiet by using for example the throttle hold switch or provide a flat throttle curve so that the pitch stick actually controls only the channel for the pitch servo, but for the later, keep the possibility to control also the throttle channel by flipping a switch for example.

In the following 7 menu points **B** - **H**, you can assign different functions by simply actuating the appropriate channel function on your transmitter. A blue flash of the Status-LED indicates that a channel has been detected. It does not matter how far or in what direction you move the stick or in what position the stick/switch was. Note the channel value itself is not important, but the change of this value is. It is therefore important that only the requested function is activated and not by accident several simultaneously. Otherwise, the MICROBEAST may not recognize the allocated channel correctly.

Receiver menu point	Function
B	pitch
C	aileron
D	elevator
E	rudder
F	tail gyro gain
G	throttle (CH5)
H	auxiliary (CH6)

If you have moved the wrong stick/switch, you can reactivate the correct function again. The MICROBEAST remembers only the last function that was operated and confirms it with blue flashing of the Status-LED.

Press the button after learning each function to save the assignment and to go to the next function. The button remains locked until you operate a new control function. **You have to assign every function** with the exception of the last auxiliary channel CH6 (this channel can be skipped by pressing the button without learning the function).

Once a channel is assigned, it is no longer available and is ignored by the MICROBEAST for the remaining process. Thus, after learning of the pitch function (menu point B) you can enable the throttle function (remove throttle hold and switch to a linear or V shape curve) and teach the throttle channel by re-operating the collective stick (menu point G). The pitch channel is now no longer considered, as this channel has already been assigned previously!

If the Status-LED stays red, it means that there is no valid remote control signal available. In this case, a channel assignment is impossible! If the Status-LED doesn't turn blue after a few seconds, check if the receiver is properly bound to the transmitter (bind already done successfully?) and that a receiver of the correct type is selected in receiver menu point **A**. If a wrong receiver type has been selected, switch off the power and re start the receiver type procedure.

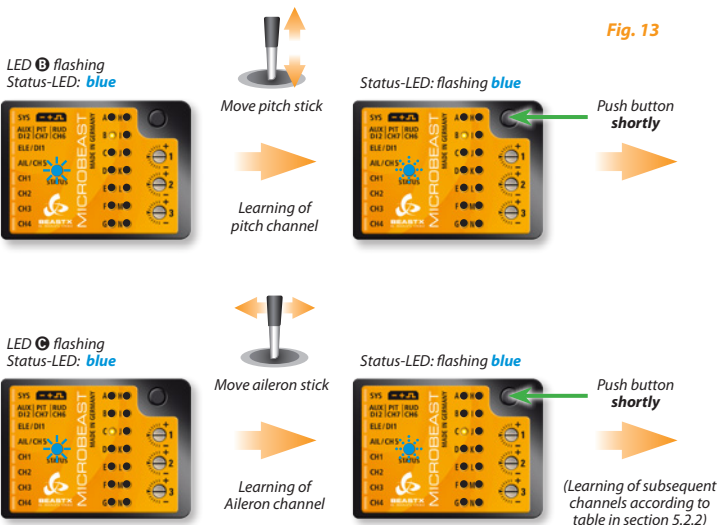

By pressing the button at receiver menu point $\text{\textcircled{B}}$ the menu LED jumps directly to receiver menu point $\text{\textcircled{N}}$.

5.3 Programming the Failsafe (receiver menu point ①)

At receiver menu point ① you have to program the fail-safe position for the throttle channel. If during operation, the received signal is interrupted, the throttle servo / motor controller (connected to the output CH5) is automatically reset to this fail safe position. To avoid accidents, you should program electric motors to “off” and reduce throttle on nitro helicopters to idle.

We recommend to directly connect speed controller and additional functions to the receiver to use the Failsafe / Hold functions of the remote control system (see 4.2.1). But you can also CH5 and CH6 on the MICROBEAST for these functions!

Set the throttle channel on your remote control to the desired position and press the button **briefly**. If you did not connect a function to CH5, anyway press the button to complete setup.

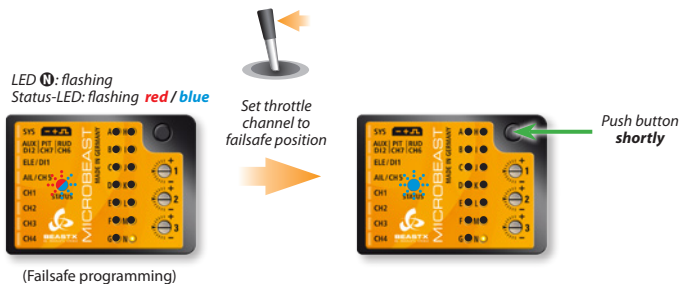

Fig. 14

For the other channels there is no fail-safe programming. In case of interruption of the received signal, these channels just hold the position corresponding to the last valid signal

This completes the basic receiver setup and the MICROBEAST will go into sleep state after the button is pressed (all menu LEDs flash). Power off the unit and proceed as described in the next chapters.

6. SETUP PROCEDURE OVERVIEW

After power on, or on exit of the receiver type setup, the MICROBEAST will initialize. **During this phase, do not move the MICROBEAST unit or the helicopter.** First the MICROBEAST runs a short LED test and then the firmware version is displayed for 3 seconds. After that, the running LEDs **A** to **G** show the calibration of the sensors and the LEDs **H** to **I** the initialization of the receiver inputs.

When the system is ready it does a short move of the swashplate servos and the Status-LED turns blue if the tail gyro is in HeadingLock mode or purple in Normal-Rate mode. For about 10 seconds you can see one of the LEDs **A** - **I** light according to the current amount of tail gain.

The programming of the MICROBEAST works in the following way:

There are two menu levels. From ready mode (flight mode) you can always get into the one or the other menu level. A change between the menu levels is not possible; you always have to first get out of the current level to enter in the other menu level. Each level includes several setup points. The yellow LEDs next to the letters shows at which setup point you are currently. Note that the two menu levels have a different number of setup points.

- To access the Setup menu you keep the button pressed (several seconds) until LED **A** stops flashing and lights up continuously. In this menu all the basic settings are made to adjust the MICROBEAST to your helicopter.
- To access the Parameter menu, press and hold the button briefly until the LED **A** starts to flash quickly and immediately release the button. This menu is used to fine tune the flight characteristics and is mostly needed at the airfield.
- While in one of the menus you normally select the different options by giving an input with the tail stick to the left or right. The momentary selected option is indicated by the color of the Status-LED. Possible colors are: off, purple, flashing red, red, flashing blue and blue. On some of the menus you might have to adjust settings with other stick functions.
- While in one of the menus, a short push on the button will switch to the next menu point. It is also possible to skip a menu point. Therefore do not move any stick while being in the menu point you want to skip, and just press the button once again.

After the last menu point, a short press on the button will exit the menu. Then the MICROBEAST is ready to fly again. If there is no stick or button input for 4 minutes while being in one of the menus, the MICROBEAST will exit the menus automatically. (This is not true in the setup points **D**, **G**, **I** and **J** to give you enough time to adjust the mechanical setup of your helicopter).

⚠ Never fly while the MICROBEAST is in one of the setup or parameter menu!

In this condition the gyro control and the stick controls are disabled.

Operation Mode

Menu LEDs: Amount of tail gain **A**=0% to **N**=100%
(only after powering up or when adjusting the gain)

Status-LED:

Tail gyro mode:
off, flashing blue or blue
= HeadingLock mode

purple = Normal-Rate mode

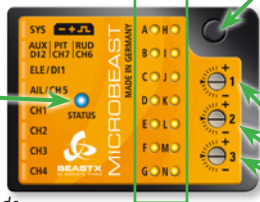

Button:

- to enter setup menu push down several seconds until LED **A** is steady on
- to enter Parameters menu push shortly until LED **A** is flashing

Dial 1: cyclic gain

Dial 2: direct cyclic feed forward

Dial 3: tail dynamic

Menu selection

Menu LEDs: ☀ steady on = setup menu
☀ flashing = parameter menu

Status-LED:

off
purple
red flashing
red
blue flashing
blue

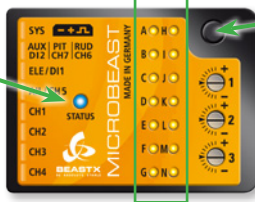

Button:

press shortly for next menu point

Fig. 15

Selection by **tail** stick input or **aileron / elevator / pitch** stick within menus as needed.

6.1 Setup menu

No Menu LED is on
Push button for about 3 seconds



Operation mode

Menu LED **A** steady on



Setup menu – menu point **A**

Fig. 16

6.2 Parameter menu

no Menu LED is on
Press button shortly



Operation mode

Menu LED **A** is flashing quickly



Parameter menu – menu point **A**

Fig. 17

6.3 Example: Selection within the menus



By moving the tail stick to the left or right, you can select the different options within a menu point.

The number of possibilities depends on the menu point.

Status-LED:

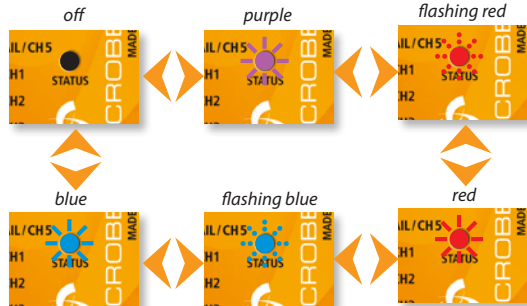

Fig. 18

6.4 Switching to the next menu point



Menu point A



Menu point B

Fig. 19

7. SETUP MENU

Before the first flight the MICROBEAST has to be adjusted to your helicopter and the used components.

When the MICROBEAST shows that the system is ready, press and hold the button down, the menu LED next to menu point **A** will begin to flash and then after a while will be steady on. Now and only now you can release the button. You just entered the setup menu in menu point **A**.

To leave the setup menu you have to skip through all menu points by pressing the button several times. After pushing the button at menu point **N** you will exit the setup menu and the system is ready for operation again. None of the LEDs **A** - **N** are glowing anymore (see chapter 6).

⚠ If there is no stick or button input for 4 minutes, while being in the setup menu, the MICROBEAST will exit the menu automatically. (This will not happen during setup points **D**, **G**, **I** and **L** to give you enough time to adjust the mechanical setup of your helicopter).

Factory Reset:

To reset the MICROBEAST to factory settings, you can, at any setup menu point, push down the button for at least 10 seconds until the LEDs **A** - **N** and **L** quickly blink one after the other to confirm the reset.

Please note that any previous configuration is now deleted. Do not attempt to fly the helicopter without doing the complete setup procedure again otherwise you will crash your helicopter. Please also note that all servo settings are lost, therefore you should unplug the servos and remove the servo horns before resetting the MICROBEAST.

The receiver type settings (see chapter 5) are not affected by the reset!

Conversely, if you change any settings in receiver type, the setup menu or parameter menu are not affected. However, you have to redo the receiver-specific settings (channel assignment and fail-safe, see sections 5.2 to 5.3).

A Mounting orientation of the MICROBEAST

The MICROBEAST unit can be mounted in nearly all possible orientations. The only restriction is that the plug connectors have to point in or against flying direction (see chapter 3).

At setup menu point **A**, you have to choose whether the MICROBEAST is mounted horizontally (printed surface 90 degrees to the main shaft) or vertically (printed surface in parallel with the main shaft).

The color of the Status-LED shows the currently selected orientation:

Status-LED	Mounting orientation
red	vertical (on the side)
blue	horizontal (flat)*

* Factory Setting



Status-LED: **red**



Status-LED: **blue**

Fig. 20

As already described (Fig. 18) you can switch between the two options by moving the rudder stick to one or other direction. For checking purposes the Status-LED will change color.

Push the button to save the configuration and to proceed to setup menu point **B.**

B Swashplate servo frequency

If you are using the MICROBEAST as stand-alone tail gyro with the optional patch cable (see section 4.2.2) it is not necessary to make any adjustments at this setup menu point.

Setup menu point **B** is for selecting the servo frequency of your **swashplate servos**.

If you do not know what the maximum pulse rate tolerated by your servos is, please select not more than 50Hz driving frequency. A higher driving frequency can lead to failure of the servos!

Analog Servos usually tolerate only 50Hz, some types up to 65Hz. Digital servos allow usually higher frequencies, but this has to be verified in the servo datasheet. You may need to check with the manufacturer of the servos.

On WWW.BEASTX.COM you can find a list of parameters for the most common servos.

To optimize the performance of the MICROBEAST, the rule is the higher the better! Nevertheless if you experience an unusually high power consumption of the receiver power supply or if the servos get hot, you should reduce this frequency.

With high frequencies, some servos run in a jerky manner, especially the fast ones like coreless or brushless servos. This is due to the high update rate that the servo receives. This is not critical and will not impact flight performance.

The color and state of the Status-LED shows the currently selected frequency:

Status-LED	Swashplate servo frequency
purple	50 Hz *
red flashing	65 Hz
red	120 Hz
blue flashing	165 Hz
blue	200 Hz
off	User defined

* Factory Setting

To select the desired servo frequency, move the tail stick repeatedly in one direction until the Status-LED lights in the correct color.

The option **“user defined”** allows you to define your own setting with the PC software.

The MICROBEAST can be used with nearly all available servo types. However, the selected servos should be adequate for flybarless operation (high torque and also fast and precise).

The quality of the servos will have a direct influence on the range of rotor blades that can be used. The more the servos are suited for flybarless operation, the less important is the flybarless specificity of the rotor blades.

The use of a bad servo-rotor blade combination will lead to several issues, ranging from oscillations during hover to unwanted reactions in fast forward flight.

Push the button to save the configuration and to proceed to setup menu point ④.

Ⓞ Tail servo center position pulse length

At setup menu point Ⓞ you can select the pulse length for the tail servo's center position. Almost all commercially available servos work with 1520 μ s. But there are a few special tail servos on the market which use a different center position pulse length.

There is a relationship between the setting of the tail servo center position pulse length and the tail servo frequency (menu point Ⓞ). If a pulse length is selected that does not allow a certain frequency, this frequency is automatically reduced. The center position pulse-setting always has priority, since a servo can run without problems at a too low frequency but can not be operated with an incorrect center position pulse.

On WWW.BEASTX.COM you can find a list of parameters for the most common servos.

The color of the Status-LED shows the currently selected servo center position pulse length:

Status-LED	Tail servo center position pulse length
purple	960 μ s
red	760 μ s
blue	1520 μ s *
off	User defined

* Factory Setting

To select the desired servo center position pulse repeatedly move the tail stick in one direction until the Status-LED glows in the correct color.

The option "user defined" allows you to define your own setting with the PC software.

Push the button to save the configuration and to proceed to setup menu point Ⓞ.

D Tail servo frequency

As with the swashplate servos at setup menu point B you can select at setup menu point D the frequency for the tail servo.

If you do not know what the maximum frequency tolerated by your servo is, please select not more than 50Hz. A higher frequency can lead to failure of the servos!

Analog Servos usually tolerate only 50Hz. Digital servos usually allow higher frequencies, but this has to be verified in the datasheet of the servo. You may need to check with the manufacturer of the servos.

On WWW.BEASTX.COM you can find a list of parameters for the most common servos.

To optimize the performance of the MICROBEAST tail gyro, the rule is the higher the better! A good rudder servo should be capable of running at least 270Hz.

Please note that depending on the tail servo center position pulse length chosen at setup menu point C, you may not be able to choose a frequency higher than 333Hz. This also applies to the “user defined” setting which might be limited to 333Hz (see also note at setup menu point C).

By moving the tail stick repeatedly in one direction you can choose the desired tail servo frequency.

Status-LED	Tail servo frequency
purple	50 Hz *
red flashing	165 Hz
red	270 Hz
blue flashing	333 Hz
blue	560 Hz
off	User defined

* Factory Setting

The option “**user defined**” allows you to define your own setting with the PC software.

Next attach a servo horn to the tail servo in such a way that the tail linkage rod forms a 90 degree angle to the servo horn (or as close as possible) and then adjust the linkage rod as described in the manual for your helicopter. For most helicopters the tail pitch slider should be centred and the tail rotor blades will then have some positive pitch to compensate for the torque of the main rotor.

Note: This menu item will not be left automatically after 4 minutes, so you have plenty of time to adjust the mechanical setup.

Fig. 21



Push the button to save the configuration and to proceed to setup menu point ③.

ⓑ Setting the Tail rotor endpoint

At setup menu point ⓑ you adjust the best possible servo throw for your tail rotor. This best throw is determined by the maximum possible control travel of the tail mechanism or based on the maximum allowed angle of attack of the tail rotor blades, that will not lead to an aerodynamic stall of these blades. Such stalls can cause very bad stopping behavior.

To adjust the limits, move the tail stick in one direction until the servo reaches the maximum endpoint without any binding or stall and release the tail stick. The further you move the tail stick the quicker the servo will steer into the given direction. If you move the servo too far you can steer the stick to the opposite direction and move the pitch slider a short way back.

Once you adjusted the maximum endpoint don't move the tail stick anymore and wait for the Status-LED to flash and then light steady red or blue, depending on the adjusted direction. Now you have saved the servo limit for one direction.

Pay attention that the steered direction of your tail stick corresponds to the direction your helicopter should turn. If this is not the case, use your transmitter's servo reversing function for the tail stick. If you're not sure in which direction the helicopter should rotate consult the manual for your helicopter.



Fig. 22

Then adjust the servo limit for the other direction. Drive the tail pitch slider by using the tail stick to the other maximum endpoint and then release the tail stick. After a short moment, the color of the Status-LED should start flashing followed by lightning steady purple, (mix of red and blue) indicating that the servo endpoint adjustment is complete.

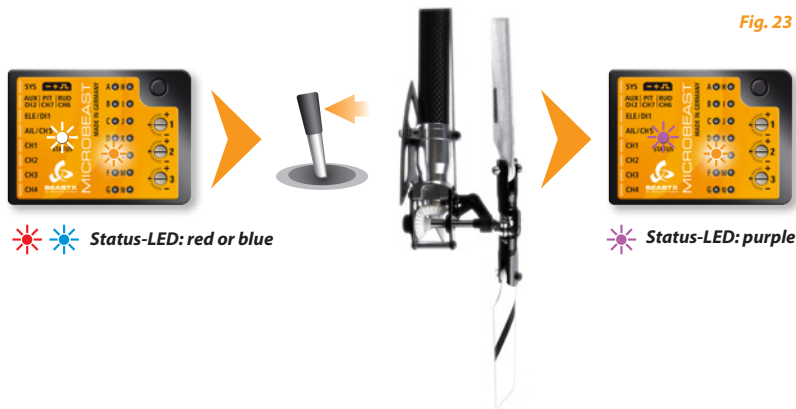

⚠ If the Status-LED does not light or lights in an unexpected color, the servo throw is obviously too small. In this case mount the linkage ball of the tail linkage rod further inward on the servo horn.

This ensures that the tail gyro of the MICROBEAST will perform in the best way and that enough servo resolution is available.

Push the button to save the configuration and to proceed to setup menu point ①.

F Setting the Tail sensor direction

Here you have to check if the MICROBEAST's tail gyro does compensate into the right direction.

At setup point F, you can find this out very easily:

The gyro always tries to steer in the opposite direction of the rotation that is applied to the helicopter.

If you move the helicopter by hand around its vertical axis, the gyro must actuate a tail servo movement to compensate this rotation. If for example you move the nose of the helicopter to the right, the gyro has to steer left the same way as you would steer left with the rudder stick (see fig. 24)

If this is not the case you have to reverse the sensor direction. This happens by moving the tail stick once into any direction. For confirmation you will see that the Status-LED will change its color.

Status-LED	Tail Sensor direction
red	normal *
blue	reversed

* Factory Setting

Once again repeat the test as described above. The MICROBEAST should now correct in the right way:

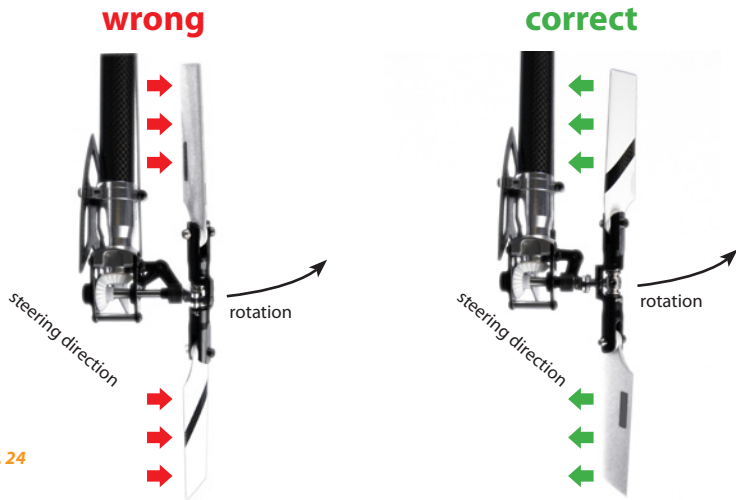

Fig. 24

Push the button to save the configuration and to proceed to setup menu point ③.

If using the MICROBEAST as a stand-alone tail gyro with the optional patch cable (see chapter 3.5) you do not have to do any further adjustments within the setup menu. Push the button repeatedly to skip the following setup menu points until no menu LED is on anymore and the system is ready for operation.

G Adjusting the swashplate servo centering

When entering setup menu point **G** connect all swashplate servos as described in chapter 3.3. They now will be running to their zero position (1520 μ s) what we call reference position here when the Status-LED is off.

This reference position is used to mount the servo horns on the servos so that they form as much as possible a 90 degrees angle to the linkage rod. Usually this will not work out perfectly depending on the servo's gear train and the servo horn, therefore you can adjust electronically every single servo in the next steps. Later, you can come back anytime to this reference position (when the Status-LED is off) for checking the mechanical setup..

If you move the tail stick to a single direction once, you can select one servo and change its center position by moving the elevator stick back and forth. Every color of the Status-LED is corresponding to a specific servo channel that is indicating its selection by a short up and down move.

If you move the tail stick once again in the same direction as before you can select the next swash servo and adjust its center position as mentioned.

Status-LED	Function
off	Swashplate servos at reference position
purple	CH 1 – elevator servo center adjust
red	CH 1 – roll (1) servo center adjust
blue	CH 3 - roll (2)/ pitch servo center adjust

You can switch back and forth between the servos as often as you need, and also switch back to the zero position for reference anytime. The already adjusted servo centers will not be lost doing this.

Note that only the adjusted servo positions are important and get stored. Those which have been set with the corresponding Status-LED colors. The Status-LED "off" only serves for reference and to plug the servo horns in the best position. For instance, if you install or replace the servos in the model.

Note: This menu item will not be left automatically after 4 minutes, so you have plenty of time to adjust the mechanical setup.

Now adjust the linkage rods according to your helicopter manual. The swashplate should now be at the midpoint and perpendicular to the main shaft and the rotor blades should have 0 degrees of pitch. Always work this out from bottom (servos) to top (blade grips).



Fig. 25

Also level and phase the swashplate driver in the correct way.

At 0 degrees of pitch the swash driver arms must be horizontal and the linkage balls of the blade grips have to be perpendicular to the spindle shaft.

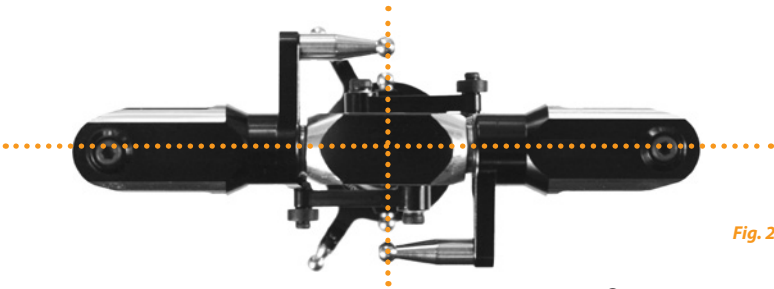

Fig. 26

Push the button to save the configuration and to proceed to setup menu point .

ⓘ Swashplate mixer

At setup menu point ⓘ you can choose the electronic swashplate mixer your helicopter requires or choose “mechanical” for switching of the electronic swashplate mixer if your helicopter has a mechanical mixer. For the electronic mixer, the MICROBEAST supports 90°, 120° and 140° swashplates. Besides these choices, you can set any swashplate geometry with the PC software and “mechanical” for switching off the “electronic swashplate mixer” option.

Which kind of CCPM your helicopter uses can be read in the manual for your helicopter.

⚠ If your helicopter requires an electronic swashplate mixer by no means use your transmitter’s swashplate mixer function!

The mixing is all done by the MICROBEAST. Deactivate the swashplate mixing in your transmitter or program it to mechanical mixing often called “H1” or “1 servo” even if your helicopter requires electronic mixing (also see section 3.2).

The color and state of the Status-LED shows the currently selected mixing type:

Status-LED:	off	purple	red flashing	red	blue flashing	blue
swashplate mixer	user defined	mechanical	90°	120° *	140°	140° (1=1)

* Factory Setting

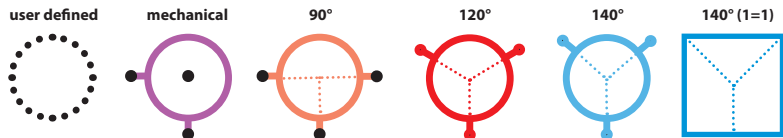

Fig. 27

Push the button to save the configuration and to proceed to setup menu point ⓘ.

① Setting the swashplate servo directions

At setup menu point ①, you adjust the correct swashplate servo directions. To facilitate this setup, you don't need to adjust every servo by its own, but just try the 4 possible combinations.

Move the pitch stick and check if the swashplate moves horizontally up and down. The direction itself is not yet important. If one or more servos are not running in the right direction, just choose another combination by giving a short rudder input. Repeat this rudder input until all servos are running in the same direction.

Status-LED	Servo directions		
	CH1	CH2	CH3
off	normal	reverse	reverse
purple	normal*	normal *	reverse *
red	normal	reverse	normal
blue	normal	normal	normal

* Factory Settings

Check now, if your control directions of aileron, elevator and pitch are correct. If this is not the case, you have to use the **servo reverse feature** of your transmitter to reverse the appropriate control function...

⚠ If the servos are still not reacting properly to aileron and elevator functions, check if the servos and receiver wires are connected as described above in section 3.3 and chapter 4. Also check if the channel assignment within receiver menu has been done correctly (section 5.2) if applicable. Additionally verify the settings of your transmitter on any remaining mixer functions (see section 3.2).

Push the button to save the configuration and to proceed to setup menu point ①.

Note: This menu item will not be left automatically after 4 minutes, so you have plenty of time to adjust the mechanical setup.

① Teaching the cyclic pitch geometry

At this setup point ①, you have to tell the MICROBEAST the available cyclic pitch range.

First don't touch any stick on your transmitter when entering setup menu point ①. Orientate one of the rotor blades so that it is parallel to the tail boom (Fig. 28). Then attach a pitch gauge to this rotor blade. The swashplate should be in the neutral position and the blades should have 0 degrees of pitch, otherwise repeat the swashplate servo centering at setup menu point ③.

Now move the aileron stick until the rotor blade has an exact 6 degrees of cyclic pitch and then release the stick (Fig. 29). If you moved the swashplate too far you can steer the stick to the opposite direction and reduce the pitch. Also by moving the tail stick to one direction you can delete the adjustment and reset the swashplate back to 0 degrees.

The direction you choose is not important, what is important is that you keep the position steady on 6° when you save and leave this menu step. It is not enough to go to 6° and then move back before saving and leaving.

When reaching 6 degrees, the Status-LED should light blue. This indicates that your helicopter's rotor head geometry is perfect for the use with a flybarless system. Otherwise, if the Status-LED's color is red or purple or even if the Status-LED is off, this indicates that your helicopter's geometry is not optimal for flybarless usage. Correct this by using shorter servo horns, shorter linkage balls on the inner washplating or longer blade grip link levers.

⚠ Always set the cyclic pitch to 6 degrees! This setup does not affect the maximum rotation rate of the helicopter but is only there to show the MICROBEAST the actual mechanical cyclic geometry. A wrong adjustment at this step may be extremely detrimental to the performance of the MICROBEAST. The blue color of the Status-LED is secondary and just for information.

Push the button to save the configuration and to proceed to setup menu point ②.

Note: This menu item will not be left automatically after 4 minutes, so you have plenty of time to adjust the mechanical setup.

1. Orientate the rotor blades parallel to the longitudinal axis of the helicopter.



Fig. 28

2. Adjust the cyclic pitch to exactly 6 degrees.

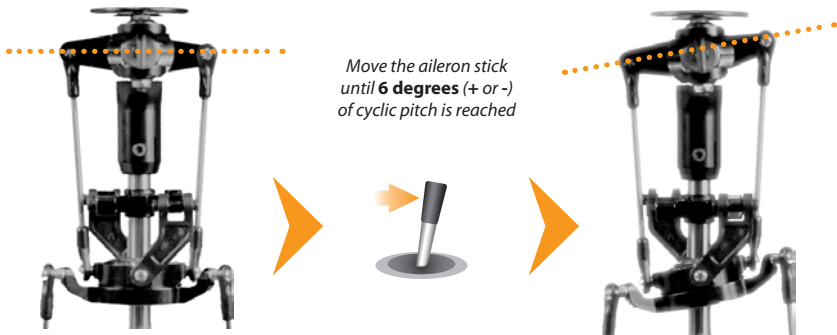



Fig. 29

Adjusting the collective pitch range

At setup point  you adjust the maximum desired negative and positive collective pitch.

Move the pitch stick all the way up and stay there. Now you can increase or decrease the maximum amount of pitch using the tail stick.

When you adjusted the desired maximum pitch angle, move the pitch stick all the way down and again increase or decrease the pitch to the minimum desired value using the tail stick.

 At this point, verify again that the demanded pitch direction on the transmitter is in the correct direction for the model. Otherwise use your transmitter's servo reversing function for the pitch channel to correct this as already described in section .

Don't use any pitch curves in your transmitter **while doing these adjustments**. Later on for the flights, you can adjust your pitch curves as you like and are used to. Setup menu point  solely serves to teach the MICROBEAST the maximum used pitch range.

Push the button to save the configuration and to proceed to setup menu point .

Adjusting the cyclic swashplate limit

At setup menu point **L** you adjust the maximum possible tilting of the swashplate for aileron and elevator. The deflection will be limited in a circular path similar to a cyclic ring function.

For adjustment proceed in the following way:

Carefully move the sticks for aileron, elevator and pitch to all maximum end points and watch out if the swashplate, the linkage rods or servos are binding somewhere or even getting not more driven.

By moving the rudder stick to the left or right, you can increase or decrease the aileron and elevator throw limiter. Always try to achieve the maximum possible cyclic throw. The higher the swashplate deflection is set the greater it will be in flight. This will achieve the maximum possible rotation rate of the helicopter without sacrificing the gyro control loop.

 Similar to setup point **L**, the color of the Status-LED indicates whether the adjusted limit allows sufficient cyclic throw. In the ideal case, the swashplate is limited only to the extent where the Status-LED still lights blue. In particular, for models that are intended to be used in 3D aerobatics, 10° to 12° cyclic throw should be possible. But even for all the other helicopters, it is recommended to adjust as much throw as possible, because otherwise the control loop may not work properly. Here, the color of the Status-LED provides a clue. If you get only purple or even no light at all, it is essential that you change the mechanical setting of your model to increase the available throw.

If afterwards any modifications are done to one of the other setup menu points which affect servo adjustments (setup menu points **G**, **H** and **K**) the cyclic swashplate adjustment has to be redone.

Push the button to save the configuration and to proceed to setup menu point **M.**

M Setting the swashplate sensor directions

At setup menu point **M**, you check if the sensors for aileron and elevator are working in the correct direction.

This can be directly verified in this menu point: If you roll or tilt the helicopter by hand the swashplate has to steer against this movement. Please refer to this on the next pages Fig. 30 and 31.

 When tilting the helicopter forward the swashplate has to move backwards, when tilting the helicopter to the back, the swashplate has to compensate forward. Same thing applies to the roll axis, when you roll the helicopter to the left the swashplate has to steer right and vice versa. Basically the swashplate has to remain horizontal while banking the helicopter.

If this is not correct, you can reverse the sensor directions by moving the tail stick in one direction. For confirmation you will see that the Status-LED changes color. Repeat this step until both sensors are correcting in the correct direction.

There are four possible displays for control to choose from, one will be correct:

Sensor direction

Status-LED	Elevator	Aileron
off	reversed	reversed
purple	reversed	normal
red	normal	reversed
blue	normal*	normal*

* Factory Setting

Push the button to save the configuration and to proceed to setup menu point **N.**

Tilt the helicopter forwards



The swashplate has to move backwards



Fig. 30

Roll the helicopter to one side

*The swashplate has to steer
to the opposite direction*



N Setting the pirouette optimization direction

When entering setup menu point **N** the swashplate will tilt forwards or backwards depending on your helicopter's setup (servos, linkages,...) this resulting tilt will correspond into a specific compass heading.

Now grab your helicopter at the rotor head and rotate it on the vertical (yaw) axis by hand. The swashplate must continue to maintain the same compass heading (see fig. 32 on the next page). The initial direction (forward or backward) is irrelevant.

If the noted swashplate tilt opposes the rotation of the helicopter and rotates against the direction of the model the pirouette optimization should be invert. This can be done by moving the tail stick in one direction. For confirmation the color of the Status-LED on the MICROBEAST will change:

Status-LED	Pirouette optimization direction
red	normal *
blue	reversed

** Factory Setting*

Now the initial setup of the MICROBEAST is finished. When you press the button now you will exit the setup menu and the MICROBEAST is ready for operation.

1. Swashplate points to the left



**2. Rotate the helicopter
around the vertical axis**



3. Swashplate must still point left, as before



Fig. 32

8. DIALS AND TAIL GYRO GAIN

Status-LED

Tail gyro mode

off, blue flashing, blue = HeadingLock
purple = Normal-Rate mode

Menu LEDs:

The amount of tail gain **A**=0% to **N**=100%
(only after powering up or when adjusting the gain)

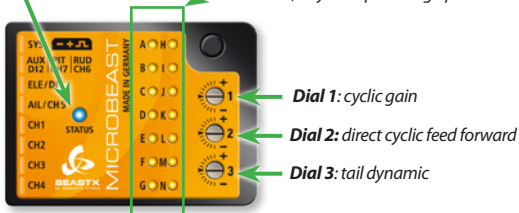

Fig. 33

To adjust the dials please only use the original plastic BEASTX adjustment tool to prevent damage to the dials!

8.1 Swashplate: cyclic gain (Dial 1)

Turn dial 1 clockwise to increase the swashplate gain.

The factory setting for the dial is horizontal which corresponds to 100% swashplate gain. For your first flights we suggest not changing this setting. However, when using very small helicopters (such as 250 or 450 size), reduce the swashplate gain slightly.

In general the higher the gain the harder the helicopter will stop after cyclic moves and the helicopter will feel more stable in the air. If the gain is too high the helicopter feels spongy and tends to oscillate especially on the elevator axis.

If the gain is too low the helicopter does not stop precisely after a cyclic movement and feels unstable in fast forward flight.

8.2 Swashplate: direct cyclic feed forward (Dial 2)

Turn dial 2 clockwise to increase the swashplate's direct cyclic stick feed forward. This is the part of the stick input that is going directly to the servos. If correctly adjusted, this relieves the control loop which will work more efficiently by only having to make residual corrections. Factory setting of the dial is horizontal which provides a good setup in most cases.

Increasing the direct cyclic feed forward will cause more cyclic stick input going directly to aileron and elevator on the swashplate. Decreasing the direct stick feed forward will do the opposite.

If the direct cyclic feed forward is too high, it will over control your cyclic input. The control loop needs then eventually to steer back. Even though you get the impression to have a more direct control, unwanted side effects may appear, like pitch backs on cyclic stops and imprecise fast forward flight.

If the direct cyclic feed forward is too low, the helicopter will feel softer, slower and less direct. The optimal point depends of many factors like blades, servos, head speed, size and mass of the helicopter.

At delivery the dial is in the middle which should be a good starting point for most helicopters.

 The direct cyclic feed forward does not affect the maximum rate of rotation! If the helicopter turns too slowly, you should check the settings of the swashplate limiter in setup menu **①**, change the control behavior in the parameter menu at point **②**, or increase the servo travels or "Dual Rate" setup in your remote control.

8.3 Tail dynamic (Dial 3)

Turn dial 3 clockwise to increase the tail dynamic. Turning dial 3 counter clockwise will decrease the tail dynamic. Factory setting of the dial 3 is horizontal which provides a good setup in most cases. You have to make sure the maximum possible tail gyro gain has already been determined (see section 8.4) before adjusting the tail dynamic.

Increasing the tail dynamic will lead to harder stopping behavior and more aggressive response to tail stick inputs. If the dynamic is too high the tail will bounce back shortly after a hard stop and feel spongy when making fast direction changes. If the dynamic is set too low the tail feels dull and stopping might be too soft. Ideally the tail should stop perfectly to the point without making any flapping noises.

8.4 Tail gyro gain (adjusted by the transmitter)

As with a conventional tail gyro, the tail gain can be adjusted by one of the transmitter's auxiliary channels. In one direction you can select the Normal-Rate mode and in the other direction HeadingLock mode.

The color of the Status-LED indicates the selected mode when the MICROBEAST is ready for operation.

Purple indicates Normal-Rate mode and blue or exceptionally flashing blue indicates HeadingLock mode. Additionally while adjusting the gain or shortly after the first start up, the current amount of gain is displayed by one of the menu LEDs for about 10 seconds. So you always know the actual amount of gain in your helicopter as percentages will depend of the used transmitter. When the gain channel is centered, this will correspond to 0% gain indicated by LED **A**. In both modes, the maximum adjustable tail gain is 100% and will correspond to LED **N**, but the actual percentage in the transmitter will depend on its brand and/or type.

For the first flight we suggest to start with a gain not higher then **F** or **G** in HeadingLock mode. To find the optimal gain, we recommend starting with a low gain, where the tail will feel very weak and will stop with overshoots. Then increase the gain step by step and you will feel the tail having more and more precise stops, and hold better and better on jerky pitch inputs. If the gain gets too high, the stops will bounce back quickly and wagging will appear in fast forward or backward flight.

⚠ Operation without using a sensitivity (gain) channel is not possible!

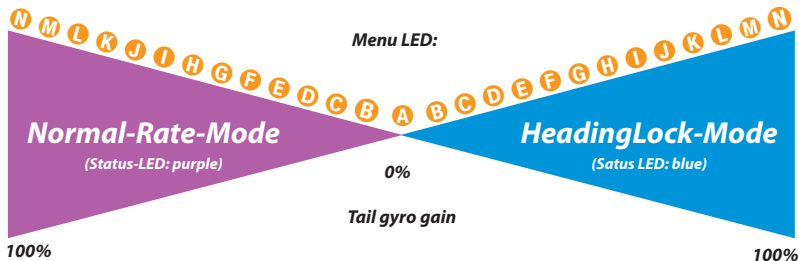

Fig. 34

9. PARAMETER MENU

When the MICROBEAST is ready, hold down the button until the Menu LED next to point **A** flashes quickly and then release the button. This is how to enter the **parameter menu**.

To switch to the next parameter menu point, just briefly press the button once again. After the last menu point pressing the button one time more exits the parameter menu and the MICROBEAST is ready for flight again. Status-LED will indicate the tail gyro mode and the LEDs **A** - **I** are off.

Single menu points can be skipped without performing any changes. Therefore don't move any stick while you are at the menu point you want to skip and just press the button shortly once again. The parameter menu has only eight points **A** to **H**, after point **H** you exit the parameter menu and the MICROBEAST returns to flight mode.



Never attempt to fly when the MICROBEAST is in one of the menus!

In this condition the control system and sometimes the stick inputs are deactivated!

A Swashplate cyclic center adjustment

The first menu point in the parameters menu gives you the possibility to easily adjust your servo centers on the flying field as for instance your helicopter is wobbling during pirouettes or when it doesn't climb out straight on quick pitch inputs.



Never use the trim functions of your remote control!

The MICROBEAST will see trim as a control command and not as servo trim.

Contrary to centering every single servo in the setup menu point ③, here you are able to directly adjust aileron and elevator without taking care about the single servos. However, the collective pitch cannot be adjusted here.

Similar to the digital trim function of most transmitters here at parameter menu point A you can adjust the swashplate "one click" by shortly moving the aileron or elevator stick in the desired direction. If you want to trim the swashplate any further repeat tapping the stick several times or simply hold the control stick pushed for a longer time to automatically perform several trim steps.

During the sub trim procedure you can delete the just performed trimming by moving the tail stick in any direction. Additionally the color of the Status-LED gives you an approximate indication of how much you did trim.

But remember that this function as opposed to the digital trim of the transmitter is not a separate trim function. Here you directly adjust the servo centers as well as you would set servo centers in the setup menu point ③. If the new position is saved once then this corresponds well to the new servo center position in the setup menu point ③. A subsequent reset to the previous state is not possible anymore!

Push the button to save the configuration and to proceed to parameter menu point ③.

B Control behavior

At parameter menu point **B** you can choose between different control behaviors for your helicopter. This includes the maximum rotation rate of the helicopter as well as how sensitive the MICROBEAST will react to stick inputs for aileron, elevator and rudder around the stick centre.

Factory setting for this option is “sport”! This should be suitable for most pilots.

If you are a rather inexperienced model pilot it is absolutely suggested to select the option „normal” for the first flights. In this state the rotation rate on cyclic and tail is very much decreased and the stick inputs around center are very gentle. Then find your individual preference by increasing the option step by step.

The choice is done by moving the tail stick in one direction until the LED indicates the desired color and state.

Status-LED	Control behavior
purple	normal
red flashing	sport*
red	pro
blue flashing	extreme
blue	transmitter
off	user defined

* Factory Setting

If you are not satisfied with the presets, you may adjust the control behavior completely through your remote control. To do so, set the control behavior to “**transmitter**” (Status-LED “blue”).

The maximum rotation rate for aileron, elevator and rudder can then be adjusted by increasing or decreasing the servo travel for the corresponding function in your transmitter. Approx. 100% stick throw (servo throw in the transmitter) are equivalent to full rotation rate in this mode. **In this mode, there is no expo programmed in the MICROBEAST and you also have to set this in your transmitter.**

When using the predefined control behaviors we do not recommend to additionally adjust control curves (Expo/Dual rates) in your transmitter as this will mix indefinable the preset curves of the Microbeast with the curves of the transmitter. But if you only make little changes (e.g. slightly increasing the servo throw to increase rotation rate) this should be no problem.

Additionally when using the setting “transmitter” by increasing the tail stick throw, in HeadingLock mode you get to an additional feature where the tail rotation rate is not limited by the gyro anymore. With this feature, extremely high tail rotation rates are possible. The state of the Status-LED shows if this high rate mode is reached. If the LED starts to flash at full tail stick input, you are on the controlled rotation rate limit. If you increase the tail stick servo travel further, the Status-LED will end up turning off when at full stick input. From this point on the rotation rate is no longer limited by the maximum gyro sensor capability, and you get into a free spinning area that can not be controlled by the gyro anymore. By further increasing the stick input (dual rates, or servo end points), the maximum rotation rate will increase even further, as far as the mechanics of the helicopter will allow it!

This feature should only be used briefly for special Show-maneuvers, for instance by temporarily switching the dual rate to higher stick throw. Note there is no tail gyro control in this unregulated range and it is very difficult to properly control the tail in this state!

Therefore, make sure that in normal flight operation the Status-LED at full rudder stick does not turn off. If it does, please reduce the servo throw or dual rate for the tail channel in your remote control.

The option “user defined” allows you to define your own setting with the PC software.

Push the button to save the configuration and to proceed to parameter menu point ③.

Ⓞ Swashplate – pitching up compensation

While in fast forward flight apply jerky collective pitch inputs to test this function. The helicopter should mainly remain in its horizontal path during climbing and descending. If the nose of the helicopter is pitching up and down heavily like a swimming dolphin, increase the value at parameter menu point Ⓞ to compensate for this effect. But, if the value is too high the helicopter might feel sluggish and lazy. Try to find the lowest suitable setting.

If the helicopter is still pitching up at the highest value, try alternatively to increase the swashplate gain (Dial 1) and use faster and stronger servos as well as rotor blades as neutral as possible (for example blades specifically designed for flybarless helis).

The currently selected value is indicated by the Status-LED color and state:

Status-LED	Pitching up behavior
purple	very low
red flashing	low
red	medium *
blue flashing	high
blue	very high
off	user defined

* Factory Setting

Move the tail stick into one direction until the Status-LED lights in the desired color. The option “**user defined**” allows you to define your own setting with the PC software.

Push the button to save the configuration and to proceed to parameter menu point Ⓞ.

ⓓ Tail HeadingLock gain

At parameter menu point ⓓ the HeadingLock gain for the tail can be adjusted:

The HeadingLock gain determines how constant the tail will maintain the rotation rate predetermined by the stick (this includes a rotation rate of height 0 = stick center position). Start with the HeadingLock gain set to low or very low and find out the highest possible tail gain in your transmitter. Then you can start to increase the HeadingLock gain:

- If the HeadingLock gain is too low, pirouettes will be inconsistent during fast forward flight or in crosswind conditions.
- If the HeadingLock gain is too high, it can happen that fast tail-direction changes no longer can be controlled clean. It is also possible that the tail will commute gently while hovering or flying around (which also often can be a sign of a stiff tail mechanics!) and bounce back when stopping the rotation.

Was the appropriate setting determined it is usually necessary to adjust the tail gyro gain in the transmitter again.

Move the tail stick into one direction until the Status-LED lights in the desired color:

Status-LED	Tail HeadingLock gain
purple	very low
red flashing	low
red	medium *
blue flashing	high
blue	very high
off	user defined

* Factory Setting

If the tail pirouettes and stops unevenly in both directions, it is recommended to set the tail gyro to Normal-Rate mode in order to test, whether the tail will drift in a particular direction during hover. If it does, adjust the tail link rod length accordingly, so that the tail blades have the required compensation pitch. Do not forget, to redo the tail rotor limits (setup menu point ③).

If you did choose in the parameter menu the control behavior “transmitter” please make sure that you are not accidentally entering the free spinning range which might be a reason for inconsistent rotation rates. See note in parameter menu ③ (control behavior).

The option “**user defined**” allows you to define your own setting with the PC software.

Push the button to save the configuration and to proceed to parameter menu point ③.

ⓑ Stick deadband

At parameter menu point ⓑ you can adjust the stick dead band for elevator, aileron and rudder. The deadband is the range around the very center of the stick where the MICROBEAST will not react. Unfortunately, some on the market available transmitters have the problem that when the sticks are brought back, after an input, to the middle position, they aren't exactly at the same center position as before. This generates a continuous deviation on the corresponding function, although the stick seems to be in the middle. This deviation is interpreted as a small input by the MICROBEAST, which lead to an unwanted rotation on that axis.

- If the stick deadband is set to low, it is difficult to find a stick position where no input is sent to the MICROBEAST. A too low setting here can lead to a tipping helicopter at take off, or a difficult to control helicopter.
- If the stick deadband is set to high, you will feel in the middle a large zone where you have no control, which makes it difficult to have precise hovering.

The choice is made by moving the tail stick into one direction until the Status-LED lights in the desired color.

The option **"user defined"** allows you to define your own setting with the PC software.

Status-LED	Stick deadband
purple	1
red flashing	2 *
red	3
blue flashing	4
blue	5
off	user defined

* Factory Setting

Push the button to save the configuration and to proceed to parameter menu point ⓑ.

Ⓜ Tail – torque precompensation (RevoMIX)

The advantage of always knowing the pitch and cyclic load on the flybarless system, allows the MICROBEAST to pre-compensate for the torque variations on the tail before any noticeable deviation. This method of torque pre compensation (RevoMIX) relieves the tail control loop and improves the tail performance especially when using MICROBEAST on helicopters with insufficient tail authority and/or extreme motor torque (well powered electric helicopters).

To see the compensation direction, you can move the collective pitch, roll and elevator control stick at any time. With active feedforward the tail rotor has to produce a deflection which is must counteract the rotor torque. Since at 0° pitch the least torque is applied by the main rotor, also tail rotor makes the least deflection as no additional deflection is added. If you pitch in positive or negative direction or move aileron or elevator control, a deflection will be added to the tail rotor which must always act against the torque of the main rotor. For helicopters with clockwise rotating main rotor, the precompensation has to steer the tail always to the left (nose of the heli to the right).

The deflection will be held always in the same direction, whether positive or negative pitch, as the torque only increases. At 0° pitch and no cyclic control input the torque is at its lowest. Once a control input is given the tail slider / the tail rotor will move slightly (!) in a given direction. Cycle through the various options and find the direction (the color of Status-LED) that matches your model. You then have four options to set the precompensation (off, low, high or by computer).

Note: The height of the deflection depends on the setting of collective pitch angles in Setup menu Ⓜ. Therefore the deflection may vary depending on the direction of pitch.

The choice is made by moving the tail stick into one direction until the Status-LED lights in the desired color.

The option “**user defined**” allows you to define your own setting with the PC software.

Status-LED	torque precompensation
purple	off *
red flashing	low - normal direction
red	high - normal direction
blue flashing	low - reverse direction
blue	high - reverse direction
off	user defined

* Factory Setting

Push the button to save the configuration and to proceed to parameter menu point Ⓜ.

G Cyclic response

With point G can be set how aggressive the MICROBEAST responds to cyclic control commands (roll and pitch). This can reduce the usual uniform and linear control feeling of flybarless systems and approach it to the feeling of a flybared helicopter.

If you want to use this feature, start from the “slightly increased” setting, gradually increasing to the desired level, until you have found your ideal setting.

A too high setting will result in uncontrollable, inaccurate rotation and deteriorating stopping behavior of each control function.

How high this feature is adjustable without causing any adverse effects depends on many factors such as heli size, swashplate servos, main rotor blades, main rotor speed, servo power supply and depending on the particular heli setup.

The choice is made by moving the tail stick into one direction until the Status-LED lights in the desired color.

The option “**user defined**” allows you to define your own setting with the PC software.

Status-LED	Cyclic response
purple	normal *
red flashing	slightly increased
red	increased
blue flashing	high
blue	very high
off	user defined

* Factory Setting

Push the button to save the configuration and to proceed to parameter menu point H.

H Pitch boost

Parameter point H allows you to set up the pitch boost function. This function causes that the faster you move the pitch stick the more additional collective pitch will be exposed. This can be especially useful in 3D aerobatics when very rapid pitch changes are necessary for certain flight maneuvers, as hereby dynamically the required control stick deflection will be reduced.

However, the maximum set pitch value (Setup menu setting point **G**) will not be exceeded.

A too high setting can cause the rotor blades to stall when giving very fast pitch command. Also the collective pitch will feel slow and spongy, precisely cause the opposite effect as desired.

Start from the “low” setting, gradually increasing to the desired level, until you have found your ideal setting. How high this feature is adjustable without causing any adverse effects depends on many factors such as maximum pitch values, pitch curve, swashplate servos, main rotor blades, system headspeed, ...

The choice is made by moving the tail stick into one direction until the Status-LED lights in the desired color.

The option “**user defined**” allows you to define your own setting with the PC software.

Status-LED	Pitch boost
purple	off *
red flashing	low
red	medium
blue flashing	high
blue	very high
off	user defined

** Factory Setting*

By pressing the button you save the setting and exit the parameter menu. Now the MICROBEAST is ready for operation again!

10. THE FIRST FLIGHT

Now it's time to fly your helicopter with the MICROBEAST!

After powering up the receiver, wait until the MICROBEAST has initialized completely.

This is indicated by a short move of the swashplate servos and the Status-LED lighting steady blue or purple. It is unnecessary to have the helicopter horizontal, but important not to move it during the whole initialization. In case of wind catching the blades, you can even lay it on the side to avoid shaking.

Like we mentioned in chapter 8 the three dials should be the factory setting (centered horizontally), when using in small helicopters for safety reason dials 1 and 2 should be set to slightly below the center position. The tail gain channel should be set to point **F** or **G** (in micro or mini helicopters experience has shown even lower). Select the control behavior at parameter menu point **B** to fit your flying style.



Before the first take off, make a stick direction check and again make sure that the sensors are correcting to the right direction when you tilt, roll or yaw the helicopter by hand.

It is normal that the swashplate might moving only slowly back to its original position after a stick input and that the servos don't run at the same speed as your sticks.

In comparison to a flybar head you are not controlling anymore directly the servos but controlling rotational rates like for fly-by-wire. The control of the servo is left to the control loop in the MICROBEAST. Thus it is also normal in HeadingLock mode, that the tail servo will stay in its end position after a tail stick input or tail movement and that it does not always react immediately to a stick input. For the same reason, it is also normal that the rudder servo runs to the endpoints with small stick inputs.

We recommend to remove main and tail rotorblades before the first flight and let the motor/engine run at all speeds. **Caution: Risk of injury!**

Watch whether the swashplate automatically starts to tilt in one direction or begins to twitch at a specific speed. This usually is a sure sign that the helicopter mechanics vibrate at a very high frequent range which disturb the sensors of MICROBEAST.

Before the first flight it is absolutely necessarily to prevent the cause of these vibrations. Often simply the attachment of the cables or MICROBEAST is not optimal, so that vibrations can very easily be transferred to the MICROBEAST.

Just before lift off make sure that the swashplate is horizontal and that the tail pitch slider is near centered. You can shortly switch to Normal-Rate mode, in this mode the tail servo will always center itself if the tail stick is released.

Avoid excessive steering during lift off otherwise the helicopter may tip over!

The best way is to give a fair and direct pitch input to lift the helicopter quickly up into the air. This demands some re-education, if you have only flown flybared helicopters before.

Now at first you should try to find the maximum possible tail gain and later on do some fine tuning as described in chapters 8 and 9 if necessary.

11. VERSION DISPLAY

After powering up the MICROBEAST, it performs a brief initialization phase. A quick LED test turns all menu LEDs on simultaneously, and the Status-LED cycles through all colors. Then for about 3 seconds, the Status-LED turns red and the first two digits (X and Y) of the internal firmware version are displayed. Then, in the remaining time a running light of the LEDs **A** - **G** signals that the sensors are being calibrated and the LEDs **H** - **N** do indicate the initialization of the receiver signals.

During the initialization phase (i.e. when viewing the firmware version or later) push briefly the button and you can display the third digit (Z) of the firmware version while the Status-LED flashes purple. Press the button briefly again, and the color of the Status-LED changes to flashing blue while displaying the data version (X.Y). If you press the button third time, the Status-LED goes off and the hardware version (X.Y) of your MICROBEAST is displayed. Press the button once again to leave the version display and proceed with initialization.

Representation of values:

The representation of all values using the menu LEDs is in binary. A lighting menu LED stands for a 1, an off LED for 0. The least significant bits are **A** and **H**.

Firmware version:

The firmware version consists of three values X.Y.Z which are displayed for X and Y during the initialization, and for Z if the button is pushed during this initialization. X are displayed though menu LEDs **A** - **G**, Y through **H** - **N** and Z is using all LEDs **A** - **N**.

Data version:

The data version consists of two values X.Y which are displayed at the same time through menu LEDs **A** - **G** for X and **H** - **N** for Y.

Hardware version:

The hardware version consists of two values X.Y which are displayed at the same time through menu LEDs **A** - **G** for X and **H** - **N** for Y.

12. TROUBLE SHOOTING

Description	Reason	Solutions
<p>The MICROBEAST does not initialize.</p> <p>The Status-LED is flashing red.</p>	<p>The MICROBEAST signals a sensor failure</p>	<ul style="list-style-type: none">- Helicopter must stand absolutely still during initialization process.- Strong wind can shake the helicopter and therefore the sensors. Lay it on the side during the initialization.- Don't initialize on a vibrating support, like a car hood or trunk with a running motor. Turn off the motor!- Sensors are damaged. Return MICROBEAST for repair
<p>The Menu LEDs H to N are running up and down, MICROBEAST does not initialize.</p>	<p>The MICROBEAST has no valid signal from the receiver.</p>	<ul style="list-style-type: none">- Check the wiring. Mainly check receiver wires for polarity on both sides and correct plugging (no vertical offset by one pin)- In case of 2.4GHz, check the transmitter-receiver binding.- Check the correct receiver type is set, chapter 5.

Description	Reason	Solutions
<p>Selection in the menus with the rudder control stick does not work.</p>	<p>Too little control travel on the rudder channel.</p> <p>Connector from the rudder channel inserted incorrectly.</p>	<ul style="list-style-type: none"> - Increase the servo throw / dual rate for the rudder channel in the TX. - Check that the connector for the rudder channel (orange wire) is inserted correctly in the receiver.
<p>The sensors do not seem to work correctly.</p> <p>The tail servo does not react or reacts very slowly to rotation of the helicopter. The same happens to the elevator axis.</p>	<p>Wrong mounting orientation has been selected.</p> <p>The gain of tail gyro is too low in the transmitter or even not on the right channel</p>	<ul style="list-style-type: none"> - In setup menu point A select the correct mounting orientation. - Adjust the Gain in the transmitter - Correct wiring or setup of tail gain cable/channel.
<p>The helicopter slowly drifts by itself on aileron, elevator and/or tail.</p> <p>The swashplate is perfectly leveled and no sub trimming is present in the radio nor is any mixing function active.</p> <p>This behavior seems to be influenced by the rotor head speed.</p>	<p>This indicates to a vibration problem which interferes with the sensors of the MICROBEAST.</p>	<ul style="list-style-type: none"> - Check the whole helicopter for imbalances - In electric helicopters the motor can cause high frequent micro-vibrations - Balance the tail rotor blades very accurately - Check the tension of the tail belt - Choose another mounting position for the MICROBEAST - Try other types of gyro pads

Description	Reason	Solutions
<p>The helicopter wobbles on aileron and elevator axis.</p> <p>Reducing the swashplate gain does not help to suppress this effect completely.</p>	<p>The MICROEBAST setup is not done correctly.</p> <p>The helicopter's linkage ratio is not suitable for flybarless usage.</p> <p>The servo-blade combination is not good</p> <p>Some linkages aren't moving smoothly and freely.</p>	<ul style="list-style-type: none"> - In setup menu point ① adjust the cyclic pitch to exactly 6 degrees: the color of the Status-LED should be "blue", otherwise the linkage ratio has to be changed by using longer blade grip levers, shorter servo horns or shorter linkage balls at the swashplate. - Check if the swashplate travel for aileron and elevator is not too much limited at setup menu point ①: try to achieve a larger travel by changing the linkage ratios. - Use faster and stronger servos and/or specific flybarless blades. - Check the mechanics for any hard points. (ball linkages, blade grips) - Check if the dampers are greased - Check that the thrust bearings in the blade grips are correctly mounted.

Description	Reason	Solutions
<p>The tail oscillates in <u>horizontal</u> position slowly and irregularly while hovering.</p>	<p>The HeadingLock gain is too high.</p>	<ul style="list-style-type: none"> - Reduce the HeadingLock gain in parameters menu point D by one step and increase the tail gain at your transmitter. - Check the linkage and mechanics for absolute free movement without hard points.
<p>The tail oscillates in <u>vertical</u> position.</p>	<p>This oscillation is caused by the rotor head.</p>	<ul style="list-style-type: none"> - Decrease cyclic gain (Dial 1). - Use another rotor head dampening that better fits to rotor head speed (the higher the head speed, the harder the dampening should be).
<p>During slow hovering pirouettes, the helicopter is rolling out.</p>	<p>The pirouette optimization setting is wrong</p>	<ul style="list-style-type: none"> - Adjust the pirouette optimization in setup point D correctly.
<p>Status-LED flashes in operation mode, e.g. after landing.</p>	<p>During operation a software - reset occurred.</p>	<ul style="list-style-type: none"> - The receiver power supply does not seem to be sufficient. The voltage during operation dropped in a critical area or there was a discharge or transfer of high voltage.

If you need more support you can connect to the forum at WWW.BEASTX.COM.

LEGAL TERMS

All statements in this document have been checked for accuracy. However we cannot guarantee accuracy, integrity or actuality. Do not hesitate to send us any suggestions for improvement by e-mail to info@beastx.com.

DISCLAIMER

The provided information was proofed for accuracy and integrity. However potential mistakes cannot be excluded. We are not responsible for any damage which occurs as a result of these contents. This product contains chemicals known to the State of California to cause cancer, birth defects or other reproductive harm.

COPYRIGHTS

The actual contents of this publication are protected by copyright law. All rights reserved. Any usage of text or illustrations, even in excerpts, without our permission is illegal and culpable. Particularly this applies to the duplication, translation or usage in electronic systems. The contents of this publication contain registered trademarks, brands and common names. Although those are not expressly designated as such the safeguarding provisions apply accordingly.

BEASTX, **MICROBEAST** and **SRXL** are registered trademarks.

DECLARATION OF CONFORMITY

It is hereby confirmed that **MICROBEAST** is being produced according to EMC Directive 2004/108/EC:

Emission: IEC 55011 class B
Immunity: IEC 61000-6-1

EAR WEEE-REG. Nr.: DE 72549415

MICROBEAST OVERVIEW

SETUP MENU

(Menu LED is steady ON)

Status-LED:		off	purple	red flashing	red	blue flashing	blue
A	Mounting orientation				upright (vertical)		flat (horizontal)*
B	Swashplate servo - frequency	user defined	50 Hz*	65 Hz	120 Hz	165 Hz	200 Hz
C	Tail servo - center position pulse length	user defined	960 µs		760 µs		1520 µs*
D	Tail servo - frequency	user defined	50 Hz*	165 Hz	270 Hz	333 Hz	560 Hz
E	Tail servo - rotor endpoints	tail stick - move to right endpoint and wait / left endpoint and wait					
F	Tail - sensor direction				normal*		reversed
G	Swashplate - servo centering	reference position	CH1 center pos.		CH2 center pos.		CH3 center pos.
H	Swashplate - mixer	user defined	mechanical	90°	120°*	140°	140° (1=1)
I	Swashplate - servo directions	nor rev rev	nor nor rev*		nor rev nor		nor nor nor
J	Swashplate - cyclic pitch geometry	aileron stick – adjust 6° cyclic pitch on the roll axis (blades aligned with fuselage)					
K	Collective pitch range	collective stick on max and min position and use tail stick to adjust desired pitch					
L	Swashplate - cyclic limit	move aileron, elevator and pitch sticks – adjust max limits with tail stick					
M	Swashplate - sensor directions	rev rev	rev nor		nor rev		nor nor*
N	Pirouette optimization direction				normal*		reversed

PARAMETER MENU

(Menu LED is flashing quickly)

Status-LED:		off	purple	red flashing	red	blue flashing	blue
A	Swashplate - cyclic center adjustment	aileron and elevator stick – reset with tail stick					
B	Control behavior	user defined	normal	sport*	pro	extreme	transmitter
C	Swashplate - pitching up behavior	user defined	very low	low	medium*	high	very high
D	Tail - HeadingLock gain	user defined	very low	low	medium*	high	very high
E	Stick deadband	user defined	1	2*	3	4	5
F	Tail - torque precompensation (RevoMIX)	user defined	off*	low - nor	high - nor	low - rev	high - rev
G	Cyclic response	user defined	normal*	slightly increased	increased	high	very high
H	Pitch boost	user defined	off*	low	medium	high	very high

* Factory settings

ADJUSTMENT OPTIONS - OVERVIEW

Menu LEDs: Amount of tail gain **A**=0% to **N**=100%
(only after powering up or when adjusting the gain)

Status-LED:

Tail gyro mode:
off, flashing blue or blue
= HeadingLock mode
purple = Normal-Rate mode

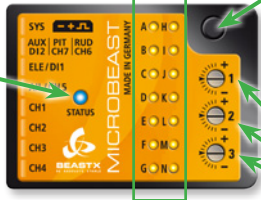

Button:

- to enter setup menu push down several seconds until LED **A** is steady on
- to enter Parameters menu push shortly until LED **A** is flashing

Dial 1: cyclic gain

Dial 2: direct cyclic feed forward

Dial 3: tail dynamic

parameter menu:



setup menu:



receiver menu:

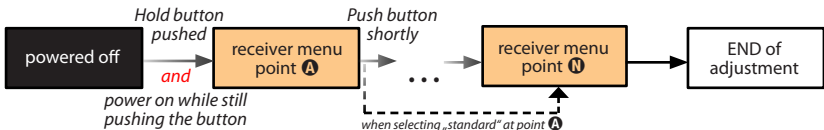

Never fly while the MICROBEAST is in one of the setup or parameter menu!

In this condition the gyro control and the stick controls are disabled.

MY SERVO SETUP

Heli						
Swashplate servo						
Status-LED	off	purple	red flashing	red	blue flashing	blue
	user defined	50 Hz	65 Hz	120 Hz	165 Hz	200 Hz
Swashplate servo - frequency						
Tail servo						
Status-LED	off	purple	red flashing	red	blue flashing	blue
Tail servo - center position pulse length	user defined	960 μ s		760 μ s		1520 μ s
Tail servo - frequency	user defined	50 Hz	165 Hz	270 Hz	333 Hz	560 Hz

Heli						
Swashplate servo						
Status-LED	off	purple	red flashing	red	blue flashing	blue
	user defined	50 Hz	65 Hz	120 Hz	165 Hz	200 Hz
Swashplate servo - frequency						
Tail servo						
Status-LED	off	purple	red flashing	red	blue flashing	blue
Tail servo - center position pulse length	user defined	960 μ s		760 μ s		1520 μ s
Tail servo - frequency	user defined	50 Hz	165 Hz	270 Hz	333 Hz	560 Hz



BEASTX
BE ABSOLUTE STABLE

Version 3.0.1 ENG - August 2011

WWW.BEASTX.COM